

TERMO DE GARANTIA DALLA COSTA

Os móveis Dalla Costa são elaborados dentro dos melhores padrões de qualidade obedecendo normas técnicas de fabricação. Garantimos este produto contra eventuais defeitos de fabricação por um período de 6 meses, contado a partir da data de venda, comprovado pela nota fiscal.

Constatado o defeito de fabricação o Sr(a) consumidor(a) deverá solicitar a assistência técnica através do estabelecimento da compra. Este termo de garantia sera anulada e sem efeito na ocorrência de qualquer das seguintes hipóteses:

- O defeito apresentado for causado pelo proprietário ou por terceiros;
- Não forem cumpridas as recomendações de montagem contidas no esquema;
- O defeito apresentado for decorrente de desgaste natural do produto, agentes da natureza transporte e armazenagem indevidos.

A matéria-prima usada é o MDF (medium Density Fibeboard), madeira ecologicamente correta proveniente de área de reflorestamento, de alta resistência e durabilidade.

O acabamento dos móveis Dalla Costa é obtido com pintura em poliéster e secagem ultravioleta.

Para Conservar a qualidade e a beleza do móvel recomenda-se os seguintes cuidados:

- Evite colocar em local excessivamente úmido;
- Evite a incidência direta de luz solar;
- Evite colocar objetos pontiagudos diretamente em cima do móvel.

Para limpeza recomenda-se somente pano umedecido em água.

DALLA COSTA WARRANT TERMS

Dalla Costa furniture is produced within the best quality criteria following technical manufacturing standards. We guarantee this product against eventual defects for a period of 6 months, starting from the sale date stated on the purchase receipt. Manufacturing defect found Mr (a) consumer (a) shall seek technical assistance through the establishment of purchase.

This warranty term will be canceled and disregarded if any of the situations below occurs:

- The defect was caused by the owner of the goods or by a third part;
- The assembly recommendation contained in the assembly intructions is not followed appropriately;
- The defect is due to natural wear of the product, nature factors or improper transport or storage ;

The used raw material is MDF (Medium Density Fibeboard), wood within ecologically acceptable standards from a reforestation area, with high resistance and durability.

The finish of Dalla Costa furniture is obtained with polyester painting and ultraviolet drying.

To keep the quality and beauty of your furniture we recommended the following care to be taken:

- Avoid putting it in places extremely wet;
- Avoid exposing in to direct sun light;
- Avoid placing sharp objects directly on the piece of furniture. It is recommended that a damp piece of cloth is used for cleaning it.

TÉRMINO DE GARANTIA DALLA COSTA

Los muebles Dalla Costa son concebidos dentro de los mejores padrones de excelencia obedeciendo las reglas práctica del conocimiento de fabricación. Asegurémonos este producto contra eventuales defectos de fabricación por una temporada de seis meses, referiéndose de la fecha de venta probada em la factura. Defecto de fabricación encontrado el señor (a) consumidor (a) se solicite asistencia técnica a través del establecimiento de compra.

Este término de garantía será cancelado, si se hubiera descubierto cualquier de las siguientes circunstancias:

- Defecto presentado fue motivo de no haber tenido cuidado;
- No cumplir las recomendaciones de montajes según el plan;
- Si el defecto presentado fuera transcurriente de la vida útil del mismo, agente de la naturaleza, transporte y almacenaje inadecuado;

- La materia prima utilizada en los muebles es el MDF (Medium Density Fibeboard), madera ecológica correta originaria de la área del repoblación, de muchísima durabilidad y soportabilidad. Las terminaciones de los muebles Dalla Costa, son obtenidos com pintura de poliéster y es secada a través del método ultravioleta.

Para la conservación de la cualidad y hermosura del mueble segue abaixo las seguintes recomendaciones:

- Evita dejarlo en un sitio excessivamente húmedo;
- Evita influencia directa de luz solar;
- Evita poner objetos afilado con punta directamente encima del mueble.

Para limpeza es recomendable solo un panõ humedecido em água.

INSTRUÇÕES DE MONTAGEM

C711

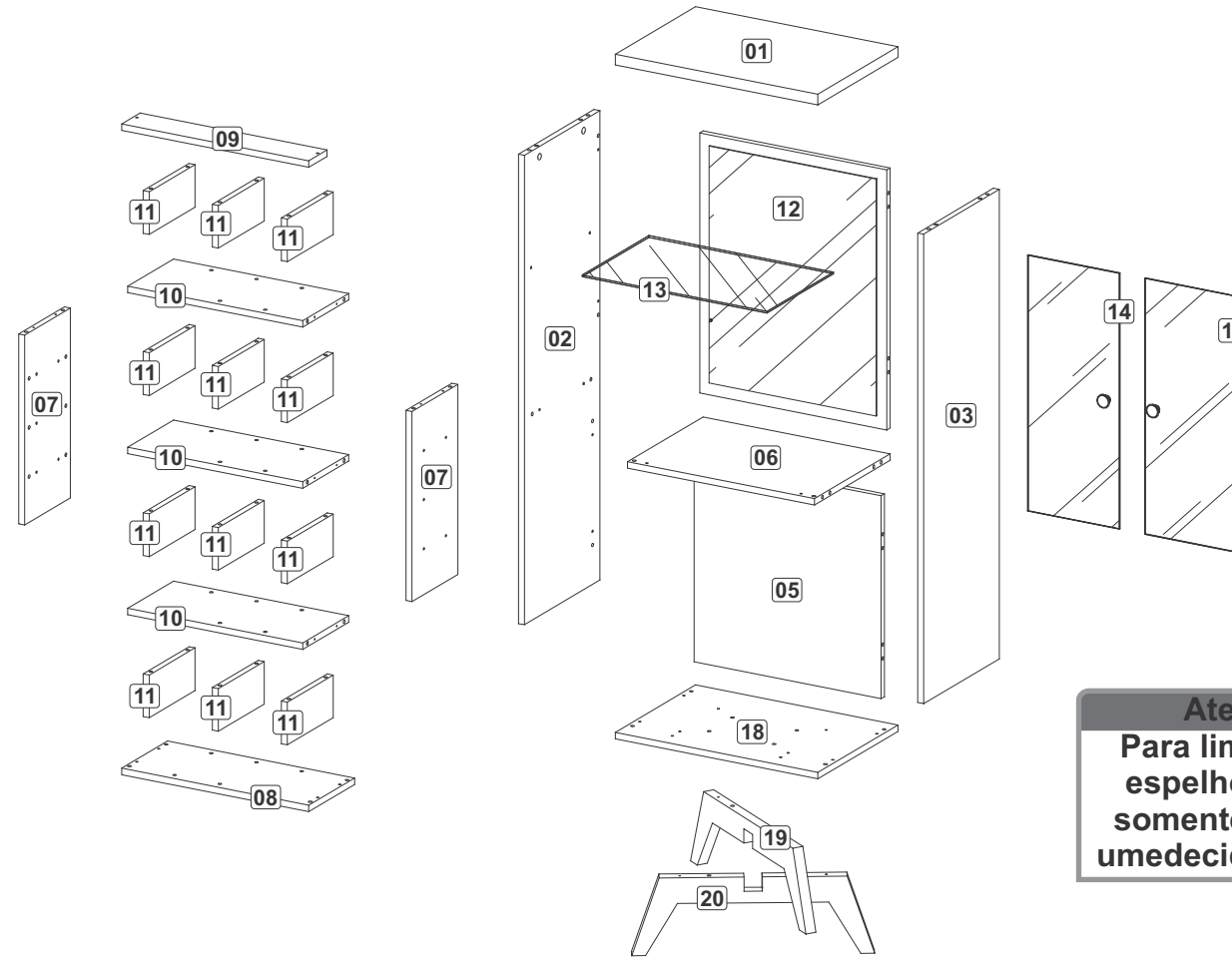

Atenção:
Para limpeza dos espelhos utilizar somente um pano umedecido em água

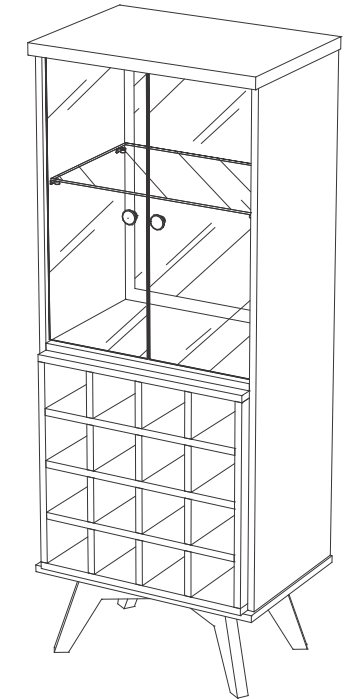

Denominação

- Tampo
- Lateral Esquerda
- Lateral Direita
- Costa Inferior
- Prateleira
- Divisão Nicho
- Base Nicho
- Travessa Superior Nicho
- Travessa Horizontal Nicho
- Travessa Vertical Nicho
- Costa Superior
- Prateleira Vidro
- Porta Vidro
- Base
- Pé Superior
- Pé Inferior

Lista de peças / Parts list / Lista de piezas







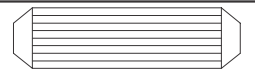
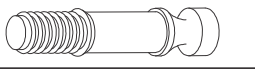

Description

- Top
- Left Side
- Right Side
- Lower Back
- Shelf
- Box Division
- Box Base
- Upper Box Crossbar
- Horizontal Box Crossbar
- Vertical Box Crossbar
- Upper Back
- Glass Shelf
- Door Shelf
- Base
- Upper Feet
- Lower Feet

Denominación

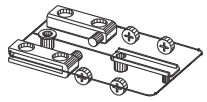
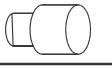
- Tapa
- División Izquierda
- División Derecha
- Revés Infeior
- Estanteria
- División Nicho
- Base Nicho
- Travesaño Superior Nicho
- Travesaño Horizontal Nicho
- Travesaño Vertical Nicho
- Revés Superior
- Estanteria Vidrio
- Puerta Vidrio
- Base
- Pie Superior
- Pie Inferior

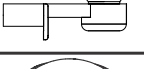
Lista de Ferragens / hardware list / Lista de materiales

A		8x30	87
B			16
C			16
D		M4 x 16	02
E		3,5 x 25	02
F		4,0 x 40	26
G			02
H			04
I			02
J			04
K			02
L		Ø19mm	12

M Ó V E I S
DALLA COSTA

MÓVEIS DALLA COSTA LTDA - RUA ARLINDO FRANKLIN BARBOSA, 3250
BAIRRO SÃO ROQUE - CAIXA POSTAL 71 - CEP 95700-000
FONE (55) 54 3455 4900 - FAX (55) 54 3455 4949
BENTO GONÇALVES - RIO GRANDE DO SUL - BRASIL
e-mail: dallacosta@dallacosta.com.br - HOMEPAGE: www.dallacosta.com.br

