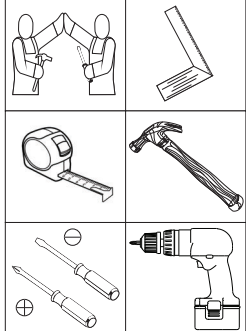
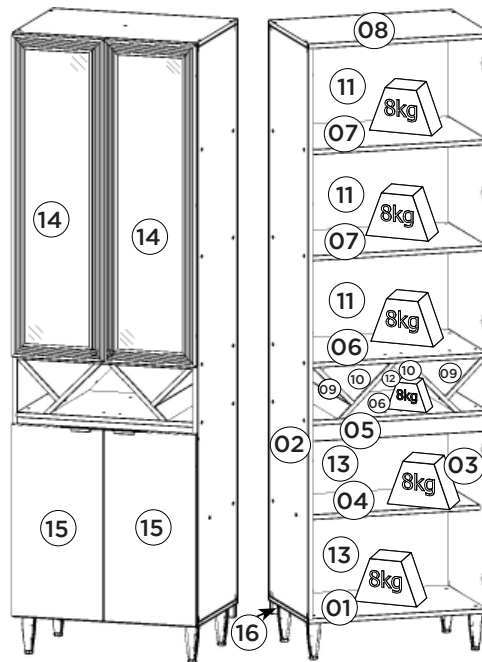

**HENN**Ind. e Com. de Móveis Henn  
Mondai - SC - Brasil

☎ +55 49 3674.3500

 @moveishenn  
www.henn.com.br
**INSTRUÇÕES DE MONTAGEM****INSTRUCCIONES DE MONTAJE  
ASSEMBLY INSTRUCTIONS****Cristaleira 4 Portas Essência | Gabinete 4 Puertas Essência | Cabinet 4 Doors Essência**Referência/Cor  
c C565-134 - Areia HP/NatureRequisitos para montagem  
Requisitos para la montaje  
Assembly RequirementsImagens meramente ilustrativas  
Imágenes meramente ilustrativas  
Images for illustration only**AVISO**

Para limpeza de seu móvel, use uma flanela seca ou umedecida, e não utilize produtos químicos que possam danificar seu produto.

**SISTEMA DE MONTAGEM**

O sistema de montagem dos produtos, funciona de acordo com a ordem crescente dos números indicados no desenho. Ex: 01, 02, 03, 04... até a conclusão da montagem.

**ADVERTENCIA**

Para limpieza de su móvil, use una flanela seca o húmeda, y no utilice productos químicos que puedan dañar su producto.

**SISTEMA DE MONTAJE**

El sistema de montaje de los productos funciona de acuerdo con el orden creciente de los números indicados en el dibujo. Ej: 01, 02, 03, 04... hasta la conclusión del montaje.

**NOTICE**

To clean your furniture, use a dry or wet cloth, and do not use chemicals that may damage your product.









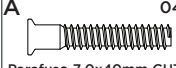
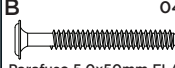

**ASSEMBLY SYSTEM**

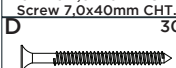
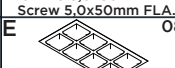
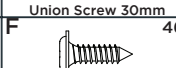
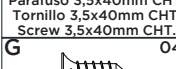
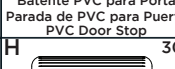
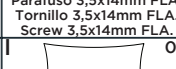
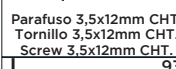
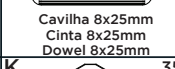
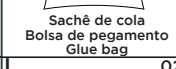

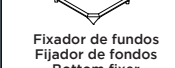
The products' assembly system works according to the increasing order of the indicated numbers. For example: 01, 02, 03, 04 ... to the end of the assembly.

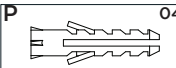
Pesos máximos recomendados com carga distribuída  
Peso máximo recomendado con la carga distribuída  
Recommended maximum weight with distributed load.**Lista de Peças | Lista de piezas | List of parts**

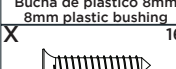
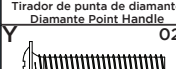
Item	Caixa Caja Box	Qtd Ctd Qty	Descrição   Descripción   Description	Medidas (mm)   Dimensions (mm)   Size (measure- ments) (mm)
01	2/2	01	Base   Base   Base	700x490x15
02	1/2	01	Lateral esquerda   Lateral izquierda   Left side	2130x490x15
03	1/2	01	Lateral direita   Lateral derecha   Right side	2130x490x15
04	1/2	01	Prateleira inferior   Estante inferior   Bottom Shelf	669x400x15
05	1/2	01	Travessa frontal   Travesaño frontal   Front crossbar	669x60x15
06	2/2	02	Prateleira Nicho   Estantería Nicho   Niche Shelf	669x490x15
07	2/2	02	Prateleira   Estante   Shelf	669x490x15
08	2/2	01	Tampo   Tapa   Top	700x490x15
09	1/2	02	Travessa Menor Chanfrada   Fuente Menor Biselada   Beveled Minor Platter	488x412x15
10	1/2	02	Travessa Nicho Chanfrada   Bandeja de nicho biselada   Beveled Niche Platter	488x298x15
11	1/2	03	Fundo   Fondo   Bottom	693x397x3
12	2/2	01	Fundo Nicho   Fondo Nicho   Niche Bottom	693x214x3
13	1/2	02	Fundo inferior   Fondo inferior   bottom Lower	693x372x3
14	1/2	02	Porta Espelho   Puerta de espejo   Mirror Door	1190x346x15
15	1/2	02	Porta   Puerta   Door	710x346x15
16	1/2	01	Travessa Sustentação   Travessa Ayuda   Support Travessa	690x50x15

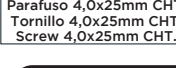
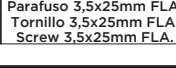
**Ferragens | Herrajes | Hardware**

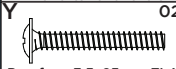
<b>A</b>	04x	<b>B</b>	04x	<b>C</b>	04x
	Parafuso 7,0x40mm CHT. Tornillo 7,0x40mm CHT. Screw 7,0x40mm CHT.		Parafuso 5,0x50mm FLA. Tornillo 5,0x50mm FLA. Screw 5,0x50mm FLA.		Parafuso União 30mm Tornillo Unión 30mm Union Screw 30mm
<b>D</b>	30x	<b>E</b>	08x	<b>F</b>	46x
	Parafuso 3,5x40mm CHT. Tornillo 3,5x40mm CHT. Screw 3,5x40mm CHT.		Patente PVC para Porta Parada de PVC para Puerta PVC Door Stop		Parafuso 3,5x14mm FLA. Tornillo 3,5x14mm FLA. Screw 3,5x14mm FLA.
<b>G</b>	04x	<b>H</b>	30x	<b>I</b>	01x
	Parafuso 3,5x12mm CHT. Tornillo 3,5x12mm CHT. Screw 3,5x12mm CHT.		Cavilha 8x25mm Cinta 8x25mm Dowel 8x25mm		Sachê de cola Bolsa de pegamento Glue bag
<b>J</b>	93x	<b>K</b>	35x	<b>L</b>	02x
	Prego 10x10mm Clavo 10x10mm Nail 10x10mm		Fixador de fundos Fijador de fondos Bottom fixer		Proteção para cantoneira Ángulo de protección Protection angle
<b>M</b>	10x	<b>N</b>	10x	<b>O</b>	03x
	Calço metal alto 3mm Calzado metálico alto 3mm 3mm high metal chock		Dobradilha metal 35mm Colo Baixo Bisagra de metal 35mm Colo Bajo Metal hinge 35mm Colo Low		Giz de correção Tiza de corrección Chalk of correction
<b>P</b>	04x	<b>Q</b>	02x	<b>R</b>	02x
	Bucha plástica 8mm Bucha de plástico 8mm 8mm plastic bushing		Puxador Pontual Diamante Tirador de punta de diamante Diamond Point Handle		Puxador PV392 160mm Tirador PV392 160mm PV392 Handle 160mm
<b>S</b>	38x	<b>T</b>	04x	<b>U</b>	04x
	Adesivo tapa parafuso 10mm Adhesivo tapon de tornillo 10mm Bolt cover adhesive 10mm		Adesivo tapa parafuso 17mm Adhesivo tapon de tornillo 17mm Bolt cover adhesive 17mm		Pé Cônico 145mm Pie Cónico 145mm Conical Foot 145mm
<b>V</b>	01x	<b>W</b>	02x		
	Conector de Montagem Conector de montaje Mounting Connector		Suporte de fixação Soporte de fijación Mounting bracket		

<b>X</b>	16x	<b>Y</b>	02x	<b>Z</b>	01x
	Parafuso 4,0x25mm CHT. Tornillo 4,0x25mm CHT. Screw 4,0x25mm CHT.		Parafuso 3,5x25mm FLA. Tornillo 3,5x25mm FLA. Screw 3,5x25mm FLA.		Etiqueta resinada Henn Etiqueta resinada Henn Henn resin label



O parafuso (C) deve ser usada somente quando este módulo for acoplado a outro módulo componível Henn.



El tornillo (C) se debe utilizar sólo cuando el módulo está conectado a otro módulo componible Henn.



The screw (C) should be used only when this module is attached to another Henn modular module.

**RECOMENDAÇÃO**

Para fixar o móvel na parede usar o suporte de fixação (W), o parafuso 3,5x14mm FLA (F), a Bucha 8mm (P) e o parafuso 5,0x50mm FLA (B).

**RECOMENDACIÓN**

Para conectar el móvil a la pared con el soporte (W), tornillo 3,5 x14mm FLA (F), el casquillo de 8 mm (P) y el 5,0 x50mm tornillo FLA (B).

**RECOMMENDATION**

To fix the furniture to the wall use the fixing bracket (W), the 3.5x14mm FLA (F) screw, the 8mm bushing (P) and the 5.0x50mm FLA (B).

1º

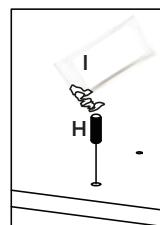
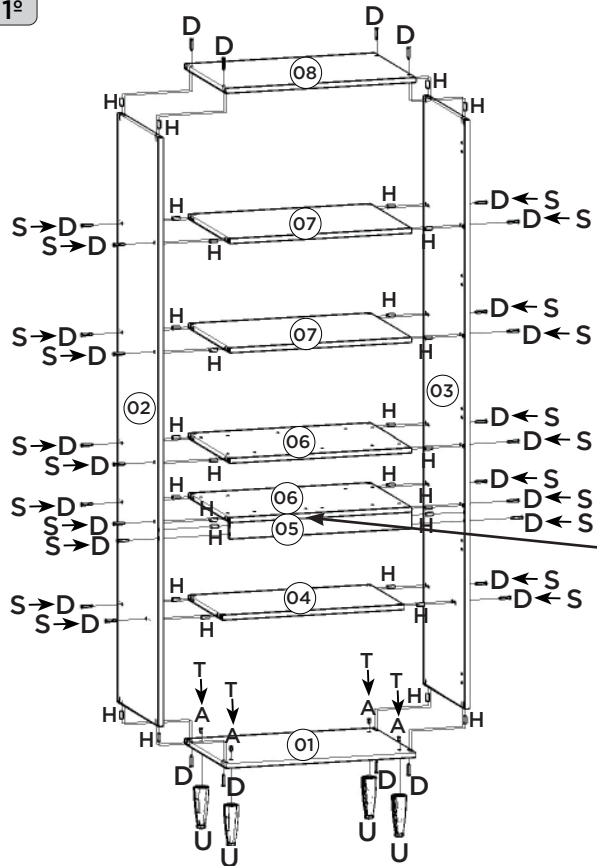

Utilizar o sachê de cola (I) em todas as cavilhas (H) do produto.

Con el pegamento sobre (I) en todos los pernos (H) producto.

Use the glue sachet (I) on all the pegs (H) of the product.

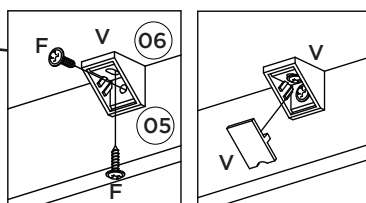

Conector de Montagem fixado Internamente

Conector de montaje fijado internamente

Mounting Connector fixed internally

2º

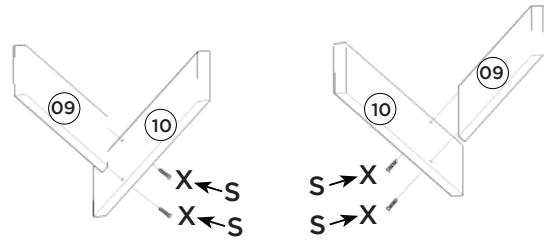

3º

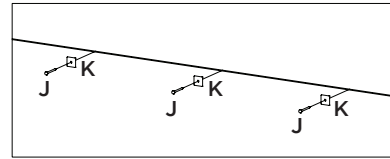
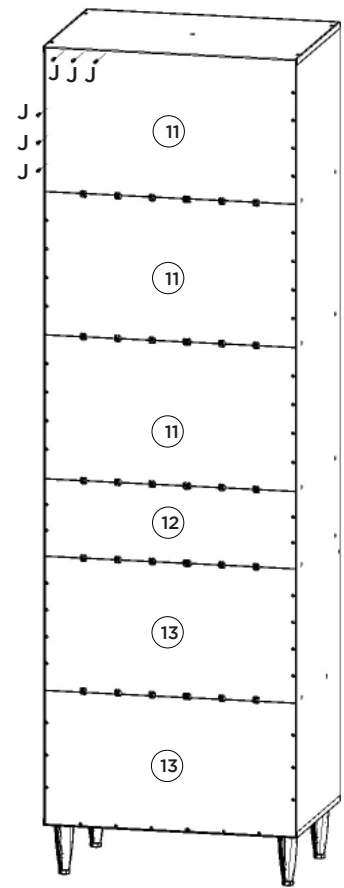

4º

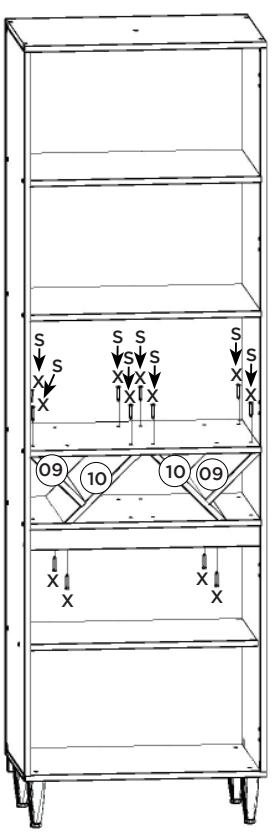

5º

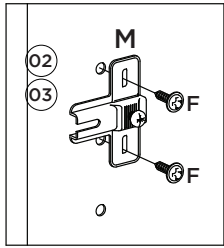
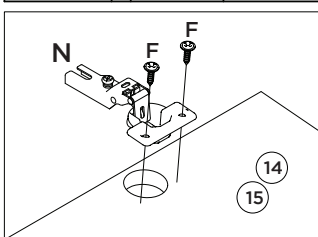
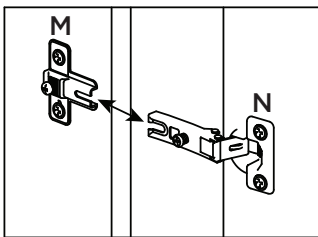
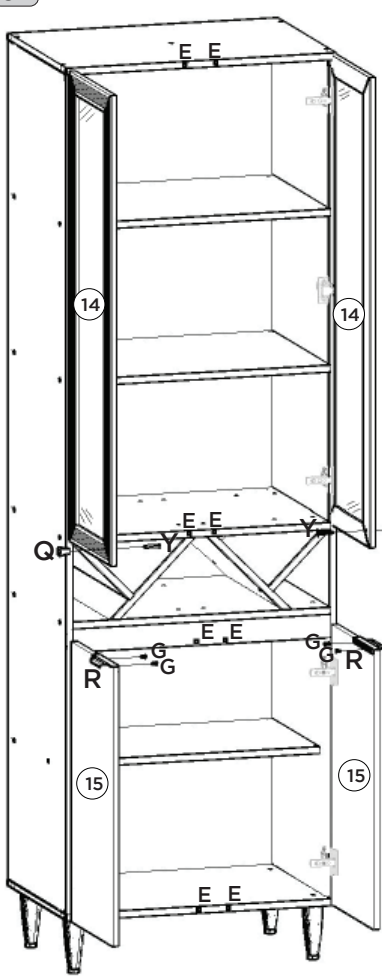

Video: Instalar e regular Dobradiças

Video: Instale y ajuste las bisagras

Video: Install and adjust hinges

6º

Opção Suspensa

Opción suspendida

Suspended Option

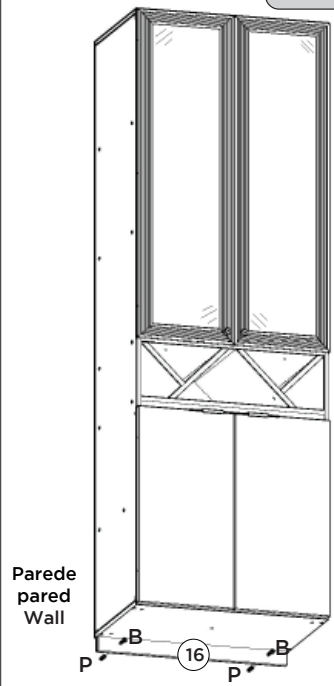

Parede  
pared  
Wall

