

DESCRIÇÃO DESCRIPTION	QT. AMOUNT	ITEM PART	COMP. MM	LARG. MM
Lateral esquerda/Lateral Izquierda/Left Side	01	01	1970	450
Lateral Direita/Lateral Derecha/Right Side	01	02	1970	450
Divisória Esquerda/División Izquierda/Left Division	01	03	1728	450
Divisória Direita/División Derecha/Right Division	01	04	707	450
Quadro Chapéu/Cuadro Techo/Hat Square	01	05	1626	450
Quadro Base/Cuadro Base/Base Square	01	06	1626	450
Quadro/Cuadro/Square	01	08	1080	450
Rodapé Frontal/Zocalo Frontal /Front Baseboard	01	09	1626	150
Rodapé Traseiro/Zocalo Trasero/Back Baseboard	01	10	1626	150
Trava de Rodapé/Traba del Zocalo/Constraint Baseboard	01	11	417	70
Batente/Batiente/Windowsill	01	12	1009	80
Encabeçamento/Techo/Header	01	15	1649	80
Porta Inteira/Puerta Larga/Biggest Door	02	17	1740	270
Porta Menor/Puerta Corta/Smaller Door	02	18	460	270
Lateral da Gaveta/Lateral De La Cajonera/Side Drawer	02	22	350	109
Frente de Gaveta/Frente De La Cajonera/Front Drawer	01	23	542	180
Traseiro de Gaveta/Trasero Del Cajon/Back Drawer	01	26	486	80
Fundo de Gaveta/Fondo Del Cajon/Bottom Drawer	01	27	507	355
Traseiro de Armário/Trasero Del Ropero/Back Closet	01	38	1760	550
Traseiro Central de Armário/Trasero Central Del Ropero/Back Central Closet	01	39	1760	544
Sanefla/Sanefla/Sight	01	43	534	90
Bastão Cabideiro/Bastón Colgador/Support Hanger	01	45	1071	-
Bastão Cabideiro Menor/Bastón Colgador Corto/Lesser Support Hanger	01	99	525	-
Porta Central/Puerta Central/Central Door	02	114	1017	270
Prateleira fixa / Estante fijo / Fixed shelf	01	159	534	384
Prateleira móvel / Estante movil / mobili shelf	02	160	534	384



# ESQUEMA DE MONTAGEM

Roupeiro Portugal

835869 Avelã / Carvalho RF

835799 Cinza RF / Camurça







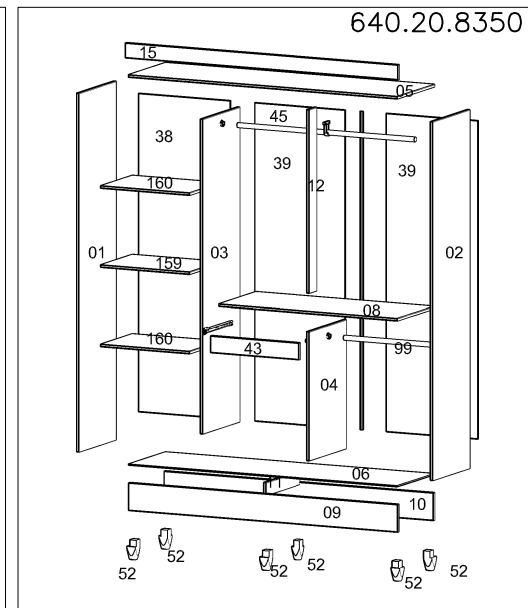
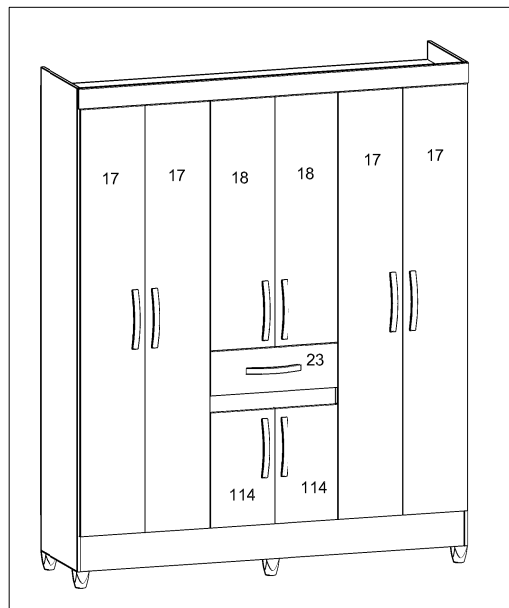

















Para Limpeza de seu Móvel: Use uma Flanela seca ou umedecida / Não use produto Químico que pode danificar seu móvel.

For Cleaness of its Furniture: It uses a dry or umedecida Flannel / It does not use Chemical product that can damage its furniture.

Limpeza del mobiliario: Utilice una franela seca o húmeda / No use productos químicos que pueden dañar el mobiliario.



640.20.8350

A  Cavilha 6x30 12	B  Cantoneira L 3 furos 04	C  Cantoneira 22x22 06	D  Fixador Reto 22	E  Calço 20
F  Parafuso 3,5x16 08	H  Dobradiça 20	I  Parafuso 3,5x25 28	J  Parafuso 4,0x50 32	K  Parafuso m4-70x22 08
L  Parafuso 4,0x30 12	M  Parafuso 4,0x35 12	N  Parafuso 3,5x12 40	O  Prego 10x10 100	P  Bucha Cilindrica 20
Q  Bisnaga de Cola 01	R  Suporte U 01	S  Sapata U 06	T  Suporte prateleira 04	U  Apoio meia cana 02
X  Puxador Lisboa 02	Y  Corrediça 02	Z  Corrediça 02	AA  Porca 08	AB  Parafuso 4x20 02

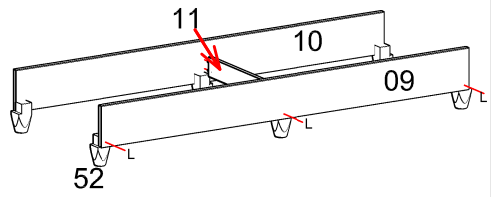

01

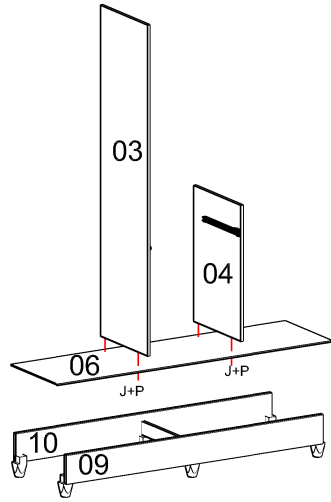

02

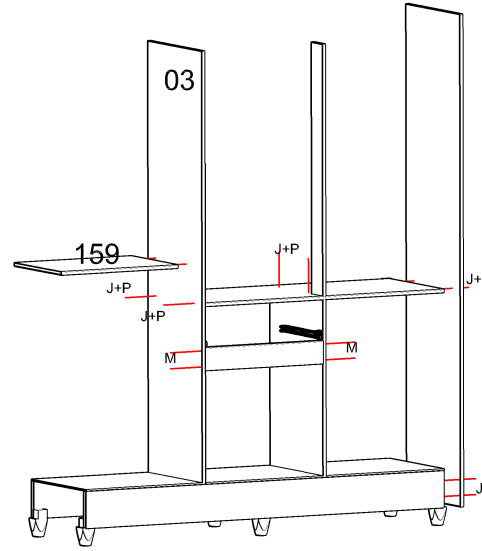

03

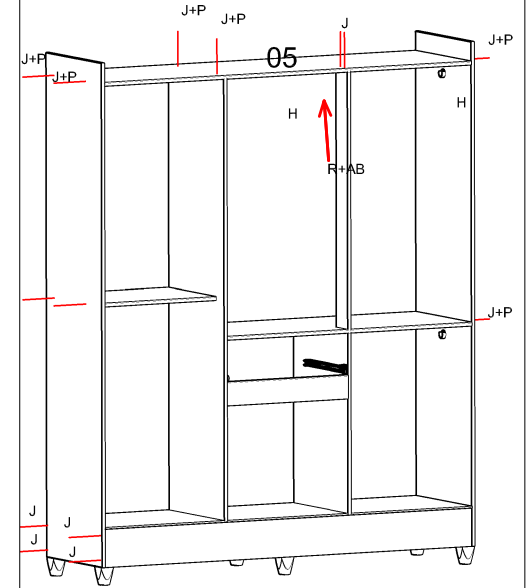

04

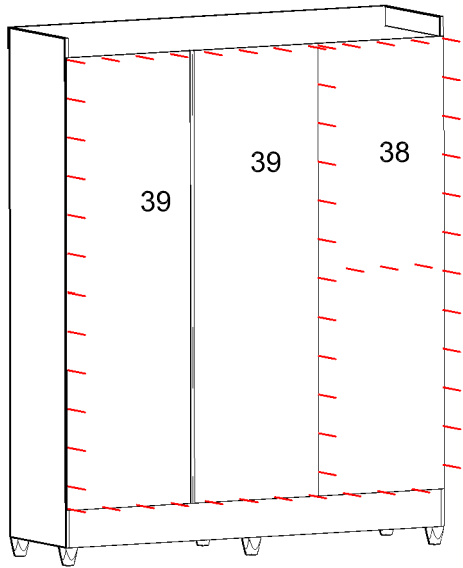

05

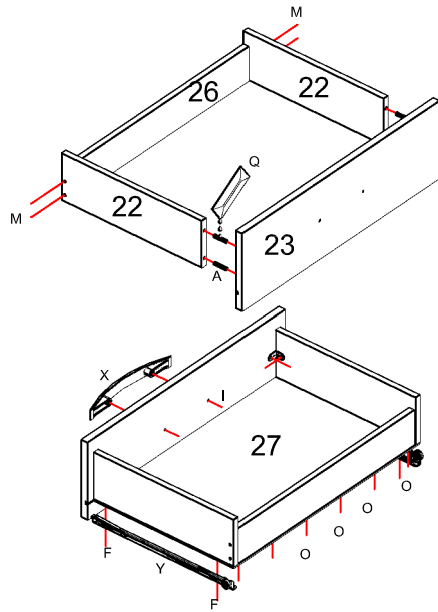

06

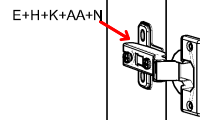

12 114

07

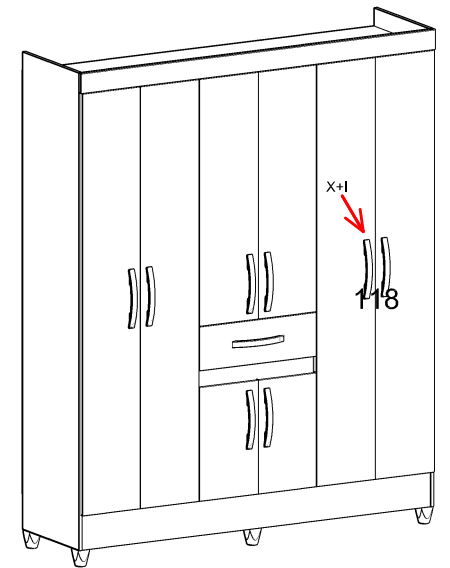

08

03