

+55 (43)3538-8300

GR. MASTER 8.6

WARDROBE MASTER 8.6
ROPERO MASTER 8.6

santos
Andirá
O móvel dos seus melhores momentos.

ESQUEMA DE MONTAGEM 949232-03

ASSEMBLING INSTRUCTIONS
MANUAL DE ARMADO



120 minutos
120 minutes

152427 • CASTANHA/OFF WHITE
152455A • ATACAMA/ATACAMA
132366A • BRANCO/BRANCO

www.santosandira.com.br

AVISO

Para limpeza do seu móvel utilize flanela seca ou levemente umedecida, sem produtos químicos!

WARNING

To clean your mobile use dry cloth or slightly moistened, no chemicals!

ADVERTENCIA

Para limpiar su mueble use un paño seco o ligeramente humedecido, sin productos químicos!



ISO 14001



ISO 9001



Descarte os resíduos de forma seletiva!

Dispose of waste selectively!

¡Deseche los residuos de manera selectiva!

Em caso de produto com espelho siga as instruções abaixo:

In the case of a product with a mirror, follow the instructions below

En el caso de un producto con espejo, siga las instrucciones a continuación:

Cole os espelhos na porta e aguarde cerca de 01 hora para fazer a colocação da mesma no produto.

Attach the mirrors to the door and wait about 01 hour to place it on the product.

Coloque los espejos en la puerta y espere alrededor 01 hora para colocarlos sobre el producto.

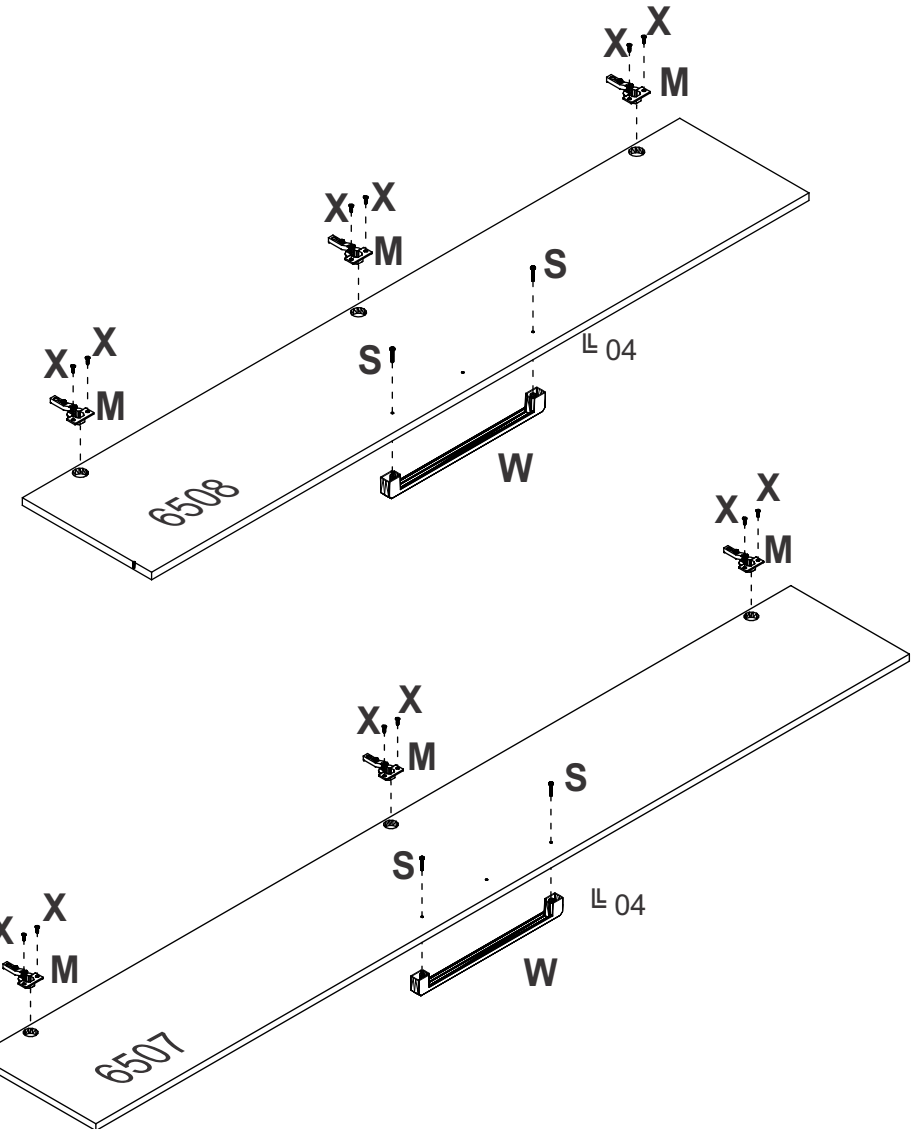

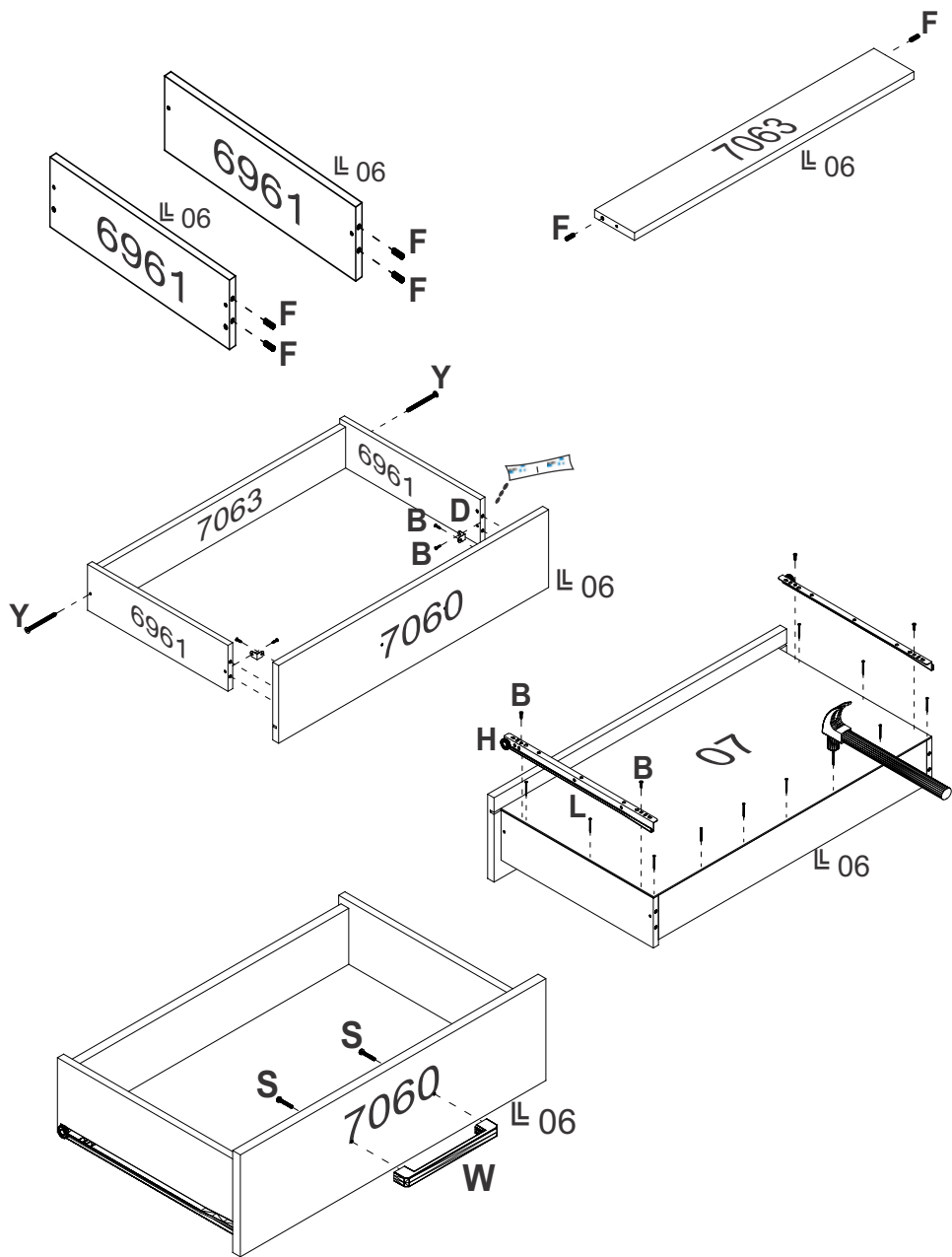





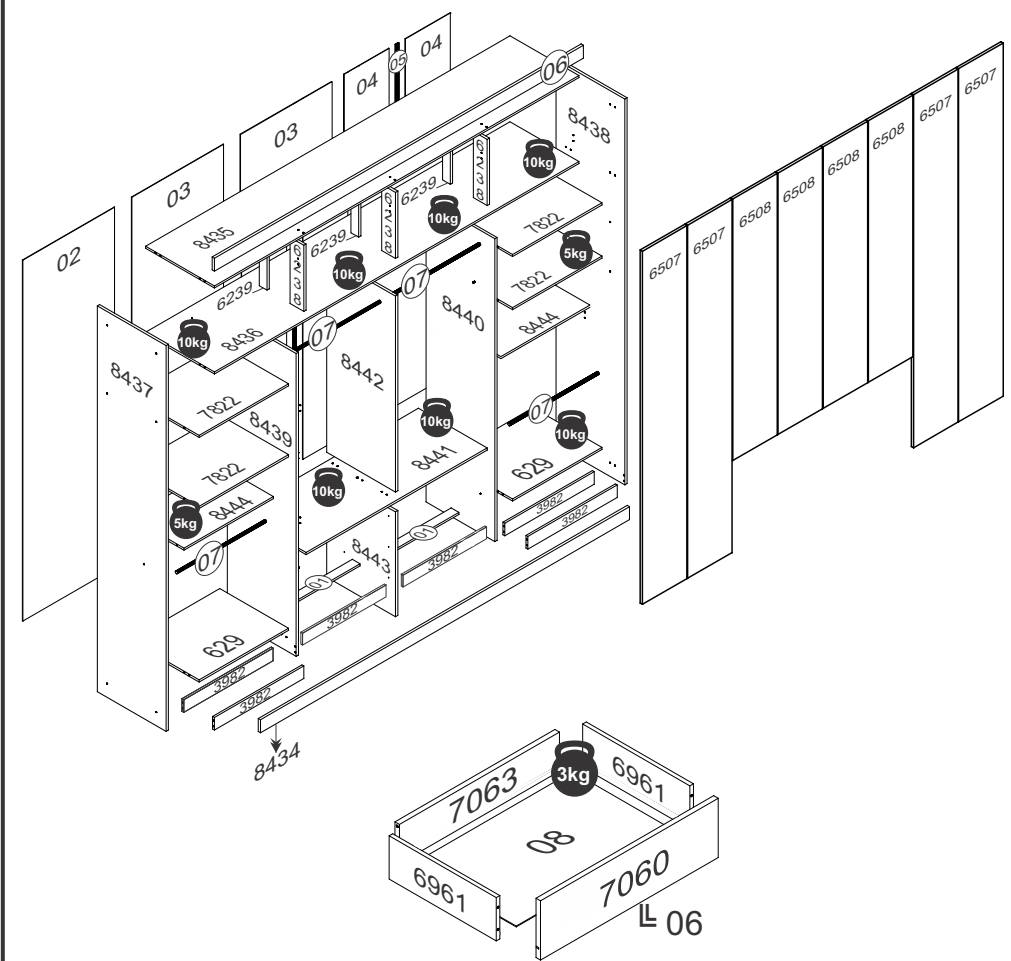





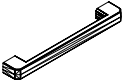

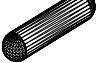

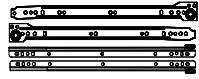

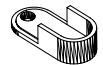

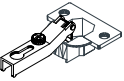
“Usar cola em todas as cavilhas”
 “Use glue on all wood pegs”
 “Utilizar cola en todos los tarugos de madera”

O peso máximo da carga exibido no desenho refere-se a objetos distribuídos de maneira uniforme sobre toda a área de contato da peça.
 The maximum loading weight the image shows refers to objects distributed uniformly over the whole part contact area.
 El peso máximo de carga informado en el diseño se refiere a objetos distribuidos uniformemente sobre totalidad de la área de contacto de la pieza.

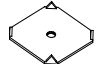
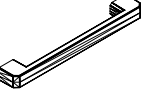

RELAÇÃO DE ACESSÓRIOS

LIST OF ACCESSORIES • LISTA DE ACCESORIOS

A 28  PARAFUSO FI CH PH 4,5x45 SCREW FI CH PH 4,5x45 TORNILLO FI CH PH 4,5x45	B 134  PARAFUSO FI CH PH 4,0x12 SCREW FI CH PH 4,0x12 TORNILLO FI CH PH 4,0x12	C 06  PUX. VERO 160mm HANDLE VERO 160mm TIRADOR VERO 160mm	D 21  CANTONEIRA METAL BRACKET METAL CANTONEIRA METAL
E 04  CUNHA WEDGE CUÑA	F 123  CAVILHA MADEIRA 6x25 WOOD PEG 6x25 TARUGO DE MADEIRA 6x25	G 28  PORCA CILINDRICA 12x09 CYLINDRICAL NUT 12x09 TUERCA CILINDRICA 12x09	H 06  CONJ. CORREDIÇA METAL 350mm SET OF METAL SLIDES 350mm CONJ. DE RIELES DE METAL 350mm
I 10  SAPATA LAT. MINI 12mm SHOE SIDE, MINI 12 mm SAPATA LAT. MINI 12mm	J 08  SUPORTE CABIDEIRO OB. HANGER HOLDER SOPORTE PARA PERCHERO	K 10  PREGO 12x12 NAIL 12x12 CLAVO 12x12	L 246  PREGO 10x10 NAIL 10x10 CLAVO 10x10
M 24  DOBRA METAL 26mm METAL HINGE 26mm BISAGRA METAL 26mm	N 02  COLA PVA GLUE PVA COLA PVA	O 10  PARAFUSO MQ PN ZB 4x25 SCREW MQ PN ZB 4x25 TORNILLO MQ PN ZB 4x25	P 10  PORCA SX MA 4 NUT SX MA 4 TUERCA SX MA 4
Q 24  CALÇO P/ DOBRA 5mm WEDGE FOR HINGE 5mm CALZO P/ BISAGRA 5mm	R 02  PARAFUSO FI CH PH 4,0x25 SCREW FI CH PH 4,0x25 TORNILLO FI CH PH 4,0x25	S 28  PARAFUSO FI FL PH 3,5x30 SCREW FI FL PH 3,5x30 TORNILLO FI FL PH 3,5x30	T 01  CASTANHA GIROFIX 12x09 MINIFIX 12x09 MINIFIX 12x09
U 01  PINO GIROFIX 35mm GIROFIX PIN 35mm TORNILLO DEL GIROFIX 35mm	V 60  FIXADOR FUNDO BACKBOARD'S FIXER FIJADOR DEL COSTADO	W 08  PUX. VERO 320mm HANDLE VERO 320mm TIRADOR VERO 320mm	X 48  PARAFUSO FI CH PH 4,0x14 SCREW FI CH PH 4,0x14 TORNILLO FI CH PH 4,0x14
Y 31  PARAFUSO FI CH PH 3,5x40 SCREW FI CH PH 3,5x40 TORNILLO FI CH PH 3,5x40	Z 02  TAPA FURO 10mm HOLE COVER 10mm TAPA DEL ORIFICIO 10mm		

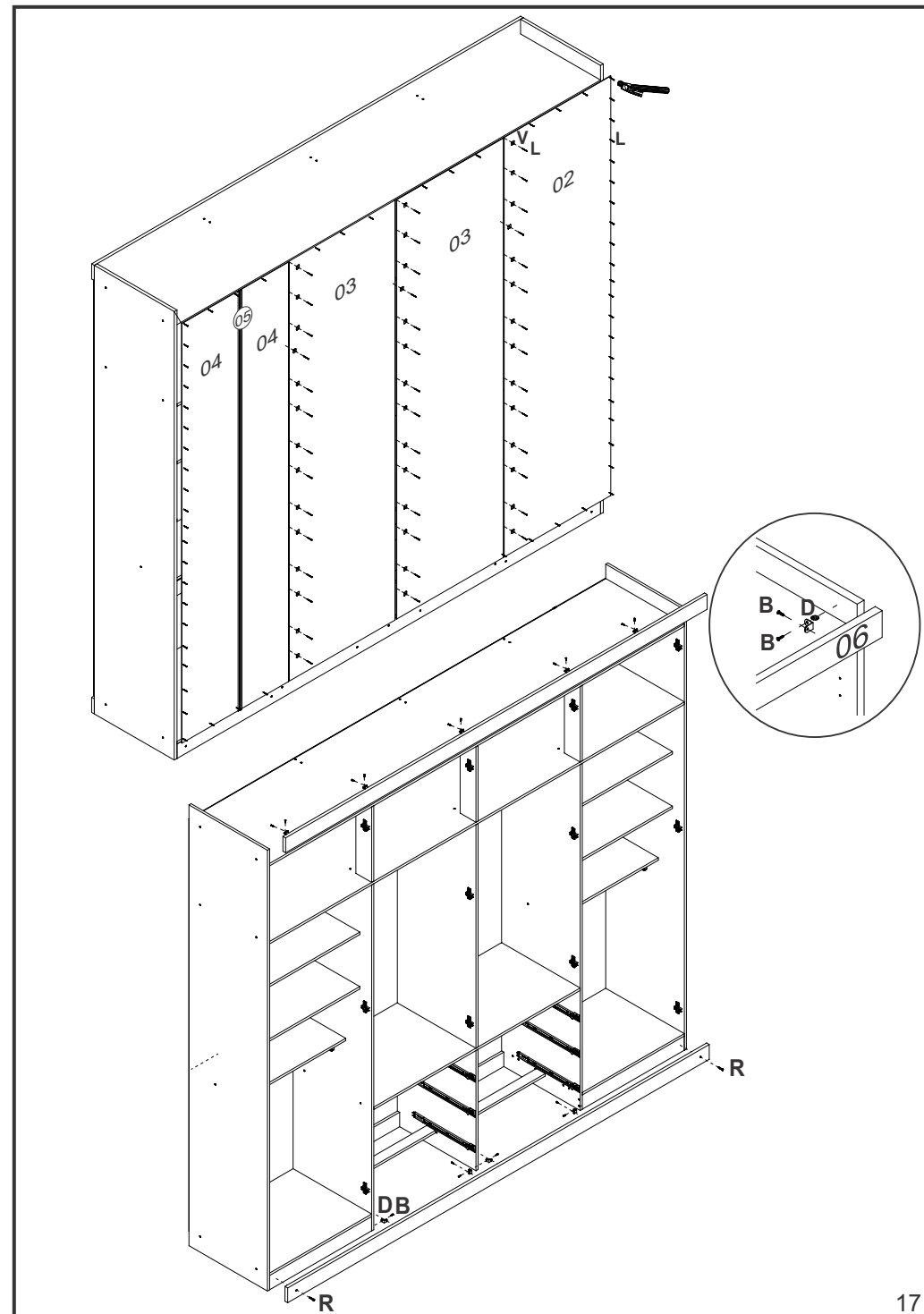

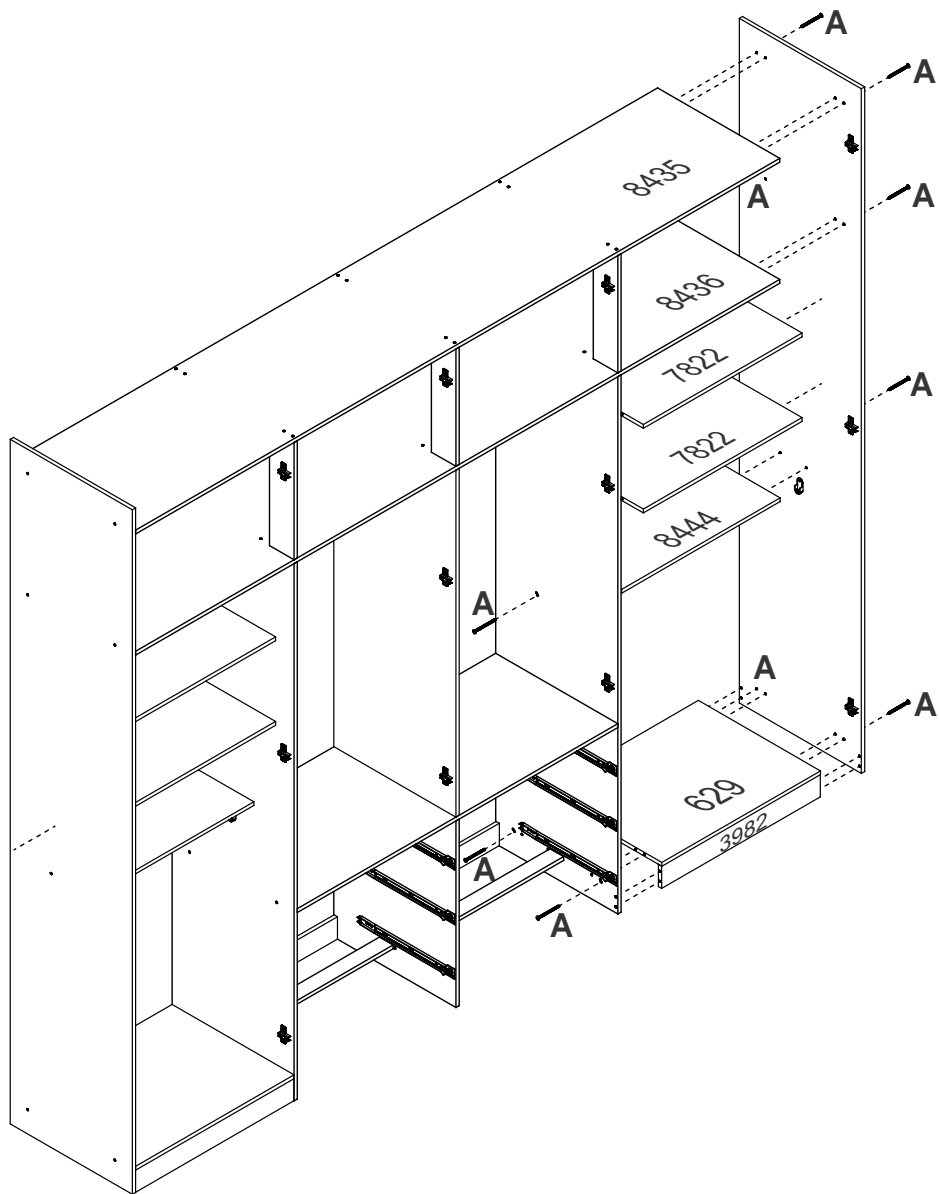

RELAÇÃO DE PEÇAS LIST OF PARTS • LISTA DE PARTES

DESCRIÇÃO DESCRIPTION DESCRIPCIÓN	VOLUME VOLUME VOLUMEM	NÚMERO NUMBER NÚMERO	DIMENSÃO DIMENSION DIMENSIÓN	QUANTIDADE QUANTITY CANTIDAD
TRAVA LOCK TRABA	01	01	582x50x12	02
VISTA SUPERIOR SUPERIOR FRONTAGE VISTA SUPERIOR	01	06	2388x73x15	01
CABIDEIRO ECO FRIZADO FRIZZED ECO HANGER PERCHERO ECO FRIZADO	01	07	573mm	04
FUNDO GAVETA DRAWER'S BOTTOM FONDO DEL CAJÓN	01	08	555x365x2,5	06
TAMPO COVER TAPA	01	629	582x448x12	01
RODAPÉ FRONT/TRAS. BASEBOARD FRONT/BACK ZÓCALO FRONTAL/TRASERO	01	3982	582x71x12	06
LAT. DE GAVETA SIDE DRAWER LATERAL DE CAJÓN	01	6961	357x101x12	12
TRASEIRO GAVETA DRAWER'S BACKBOARD TRASERO DE CAJÓN	01	7063	533x90x12	06
PRATELEIRA SHELF ESTANTE	01	7822	582x380x12	04
VISTA INFERIOR BOTTON FRONTAGE VISTA INFERIOR	01	8434	2388x73x15	01
CHAPÉU WARDROBE'S TOP TAPA SUPERIOR	01	8435	2364x448x12	01
BASE MALEIRO BASE FOR LUGGAGE RACK BASE DEL PORTAEQUIPAJES	01	8436	2364x448x12	01
TAMPO COVER TAPA	01	8444	582x300x12	02

RELAÇÃO DE PEÇAS
LIST OF PARTS • LISTA DE PARTES

DESCRIÇÃO DESCRIPTION DESCRIPCIÓN	VOLUME VOLUME VOLUMEM	NÚMERO NUMBER NÚMERO	DIMENSÃO DIMENSION DIMENSIÓN	QUANTIDADE QUANTITY CANTIDAD
TRASEIRO G.R WARDROBE'S BACKBOARD COSTADO DEL ROPERO	02	02	2035x597x2,5	01
TRASEIRO G.R WARDROBE'S BACKBOARD COSTADO DEL ROPERO	02	03	2035x594x2,5	02
TRASEIRO G.R WARDROBE'S BACKBOARD COSTADO DEL ROPERO	02	04	2035x296x2,5	02
PERFIL H H PROFILE PERFIL H	02	05	2035mm	01
PORTA DOOR PUERTA	02	6507	2018x294x15	04
PORTA DOOR PUERTA	02	6508	1496x294x15	04
FRENTE GAVETA DRAWER'S FRONT FRENTE DEL CAJÓN	02	7060	592x170x15	06
DESCRIÇÃO DESCRIPTION DESCRIPCIÓN	VOLUME VOLUME VOLUMEM	NÚMERO NUMBER NÚMERO	DIMENSÃO DIMENSION DIMENSIÓN	QUANTIDADE QUANTITY CANTIDAD
TAMPO COVER TAPA	03	629	582x448x12	01
BATENTE TOP SUPPORT BATIENTE	03	6238	373x90x12	03
BATENTE TOP SUPPORT BATIENTE	03	6239	373x50x12	03
LAT. EXT. ESQUERDA LEFT EXTERNAL SIDE LAT. EXT. IZQUIERDA	03	8437	2176x448x12	01
LAT. EXT. DIREITA RIGHT EXTERNAL SIDE LATERAL EXTERNA DERECHA	03	8438	2176x448x12	01
LAT. INTERNA ESQUERDA LEFT INTERNAL SIDE LAT. INTERNA IZQUIERDA	03	8439	1708x448x12	01
LAT. INTERNA DIREITA RIGHT INTERNAL SIDE LAT. INTERNA DERECHA	03	8440	1708x448x12	01
TAMPO DA GAVETA DRAWER'S COVER TAPA DEL CAJON	03	8441	1176x448x12	01
LAT. INTERNA CENTRAL CENTRAL INTERNAL SIDE LAT. INTERNA CENTRAL	03	8442	1103x448x12	01
DIVISÓRIA DIVISION DIVISION	03	8443	593x448x12	01

