

DESCRIÇÃO DESCRIPTION	QT. AMOUNT	ITEM PART	COMP. MM	LARG. MM
Lateral esquerda/Lateral Izquierda/Left Side	01	01	1820	448
Lateral Direita/Lateral Derecha/Right Side	01	02	1820	448
Quadro/Cuadro/Square	02	05	1282	448
Quadro Base/Cuadro Base/Base Square	01	06	1282	448
Rodapé Frontal/Zocalo Frontal /Front Baseboard	01	09	1282	150
Rodapé Traseiro/Zocalo Trasero/Back Baseboard	01	10	1282	150
Batente/Batiente/Windowsill	02	12	882	80
Encabeçamento/Techo/Header	01	15	1304	80
Porta Inteira/Puerta Larga/Biggest Door	02	17	1590	350
Lateral da Gaveta/Lateral De La Cajonera/Side Drawer	04	22	350	109
Frente de Gaveta/Frente De La Cajonera/Front Drawer	02	23	582	140
Traseiro de Gaveta/Trasero Del Cajon/Back Drawer	02	26	526	80
Fundo de Gaveta/Fondo Del Cajon/Bottom Drawer	02	27	548	355
Traseiro de Armário/Trasero Del Ropero/Back Closet	02	38	1600	638
Sanefla/Sanefla/Sight	01	43	574	70
Divisória do Gaveteiro/División De La Cajonera/Drawer Division	02	58	676	448
Porta Direita/Puerta Derecha/Right Door	01	60	372	290
Porta Esquerda/Puerta Izquierda/Left Door	01	61	372	290
Porta Central/Puerta Central/Central Door	02	67	890	290
Coluna Traseira/Columna Trasera/Back Column	01	68	1570	50











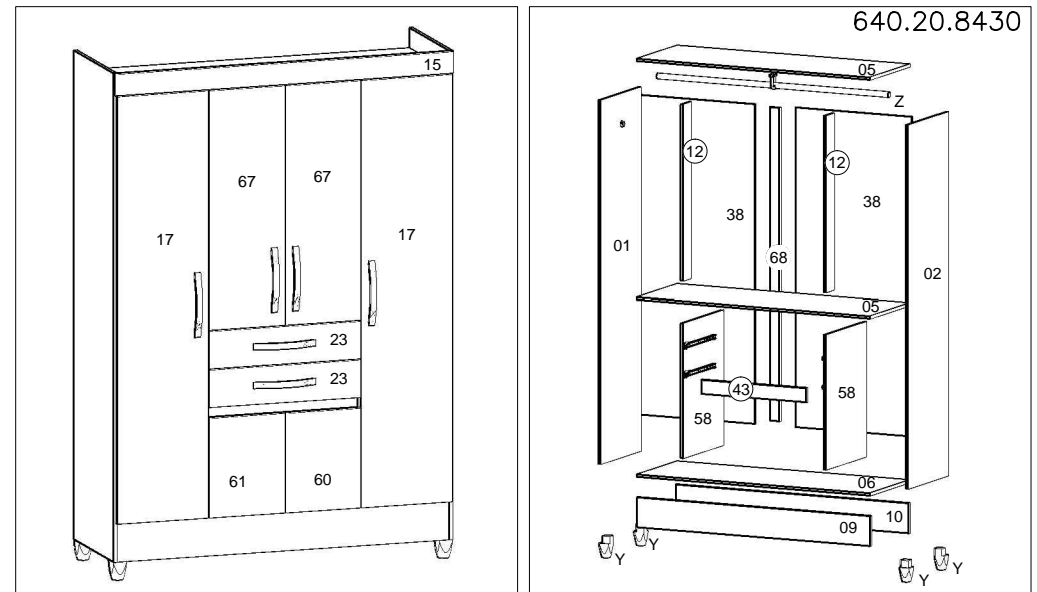







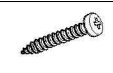

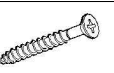

## ESQUEMA DE MONTAGEM

843720 Cinza/Preto      843860 Avelã/Carvalho

## Roupeiro Rubi

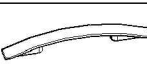
Para Limpeza de seu Móvel: Use uma Flanela seca ou umedecida / Não use produto Químico que pode danificar seu móvel.  
 For Cleanness of its Furniture: It uses a dry or umedecida Flannel / It does not use Chemical product that can damage its furniture.  
 Limpieza del mobiliario: Utilice una flanela seca o húmeda / No use productos químicos que pueden dañar el mobiliario.

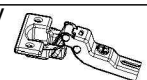

<b>A</b>  Cavilha 6x30    08	<b>B</b>  Cantoneira L 3 furos    03	<b>C</b>  Cantoneira 22x22    04	<b>D</b>  Parafuso 3,5x16    08	<b>E</b>  Parafuso M4-70x22    04
<b>F</b>  Parafuso 4,0x50    20	<b>H</b>  Par. 3,5x25 pan.    12	<b>I</b>  Parafuso 4,0x20    02	<b>J</b>  Parafuso 4,0x30    16	<b>K</b>  Parafuso 4,0x35    24
<b>L</b>  Parafuso 3,5x12    85	<b>M</b>  Porca 4mm    04	<b>N</b>  Prego 10x10    85	<b>O</b>  Buchta Cilindrica    20	<b>P</b>  Bisnaga de Cola    01
<b>Q</b>  Sapata U    06	<b>R</b>  Apoio meia cana    02	<b>S</b>  Suporte U    01	<b>T</b>  Puxador Lisboa    06	<b>U</b>  Calço    14
<b>V</b>  Dobradiça    14	<b>W</b>  Corrediça    02	<b>X</b>  Corrediça    02		

640.20.8430

