

Paneleiro 02 Portas Belize | Paneleiro 2Puertas Belize | Paneling 2Doors Belize

Referência/Cor
c C516-131 - Cinza

Requisitos para montagem
Requisitos para la montaje
Assembly Requirements

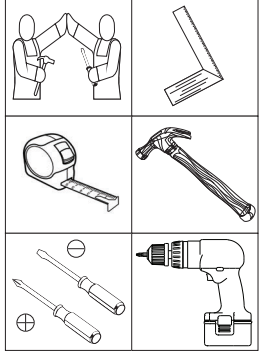

Imagens meramente ilustrativas
Imágenes meramente ilustrativas
Images for illustration only

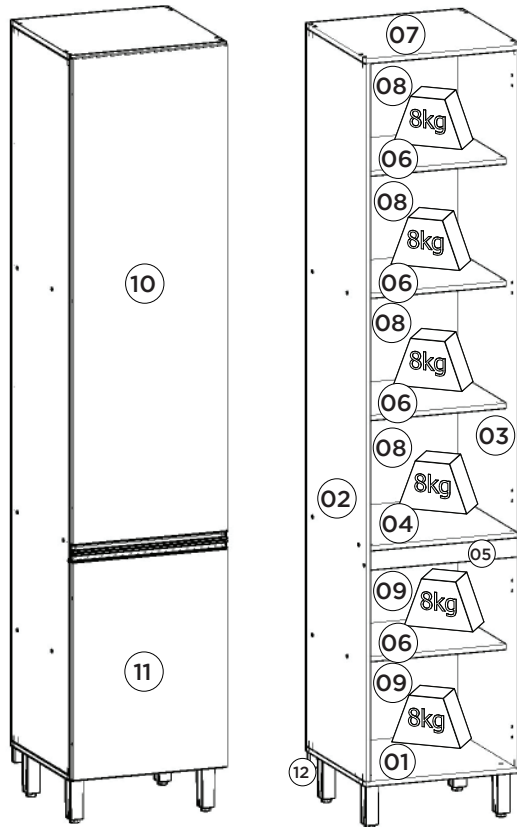

Pesos máximos recomendados com carga distribuída
Peso máximo recomendado con la carga distribuída
Recommended maximum weight with distributed load.

Lista de Peças | Lista de piezas | List of parts

Item	Caixa Caja Box	Qtd Ctd Qty	Descrição Descripción Description	Medidas (mm) Dimensions (mm) Size (measure- ments) (mm)
01	2/2	01	Base Base Base	500x490x15
02	1/2	01	Lateral esquerda Lateral izquierda Left side	2225x490x15
03	1/2	01	Lateral direita Lateral derecha Right side	2225x490x15
04	2/2	01	Prateleira maior Estante más grande Larger shelf	490x469x15
05	2/2	01	Travessa frontal Travesaño frontal Front crossbar	469x60x15
06	2/2	04	Prateleira Estante Shelf	469x400x15
07	2/2	01	Tampo Tapa Top	500x490x15
08	2/2	04	Fundo Fondo Bottom	493x378x3
09	2/2	02	Fundo Inferior Fondo Inferior Bottom background	493x366x3
10	1/2	01	Porta maior Puerta más grande Larger door	1512x496x15
11	1/2	01	Porta Puerta Door	680x496x15
12	2/2	01	Travessa Sustentação placa de suporte support plate	490x50x15

Ferragens | Herrajes | Hardware

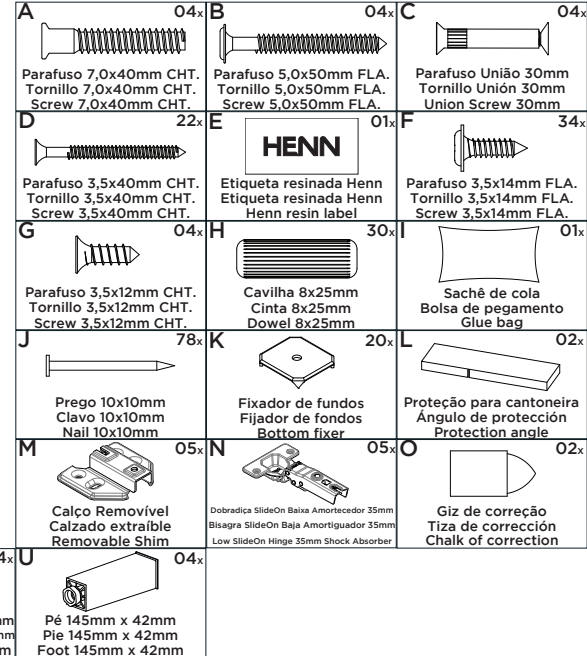

O parafuso (C) deve ser usada somente quando este módulo for acoplado a outro módulo componível Henn.

El tornillo (C) se debe utilizar sólo cuando el módulo está conectado a otro módulo componible Henn.

The screw (C) should be used only when this module is attached to another Henn modular module.

RECOMENDAÇÃO

Para fixar o móvel na parede usar o suporte de fixação (Q), o parafuso 3,5x14mm FLA (F), a Bucha 8mm (P) e o parafuso 5,0x50mm FLA (B).

RECOMENDACIÓN

Para conectar el móvil a la pared con el soporte (Q), tornillo 3,5 x14mm FLA (F), el casquillo de 8 mm (P) y el 5,0 x50mm tornillo FLA (B).

RECOMMENDATION

To fix the furniture to the wall use the fixing bracket (Q), the 3.5x14mm FLA (F) screw, the 8mm bushing (P) and the 5.0x50mm FLA (B).

1º

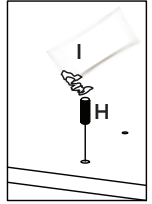
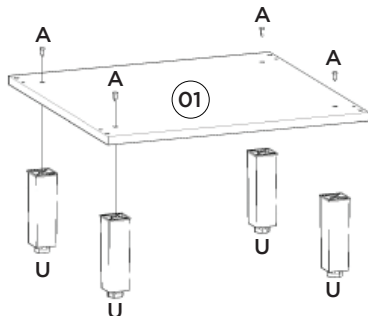

Utilizar o sachê de cola (I) em todas as cavilhas (H) do produto.

Con el pegamento sobre (I) en todos los pernos (H) producto.

Use the glue sachet (I) on all the pegs (H) of the product.

2º

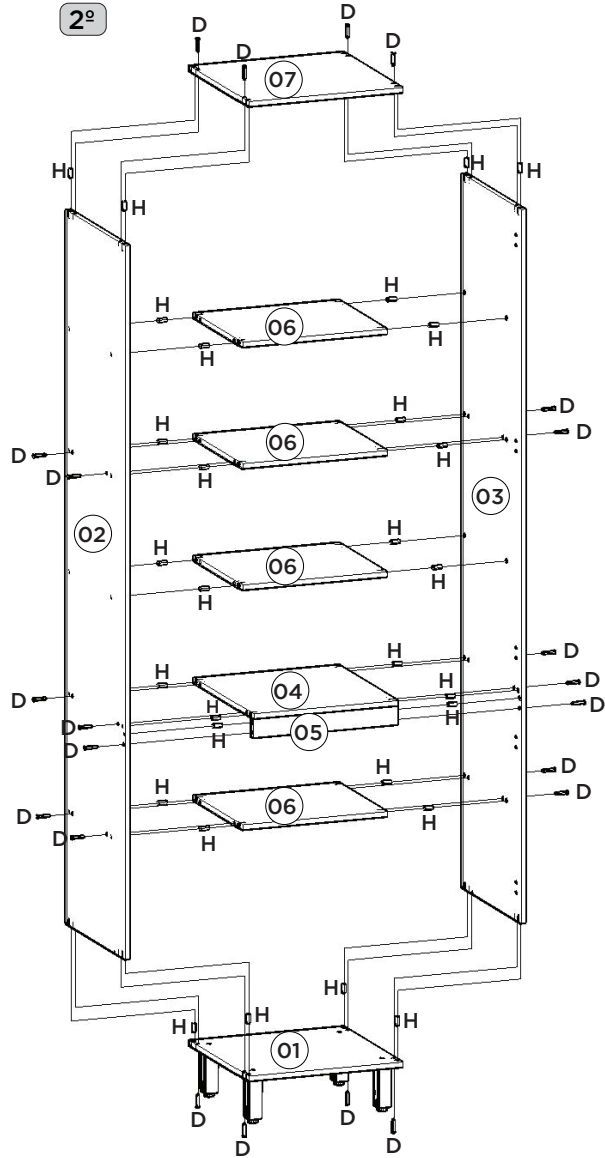

3º

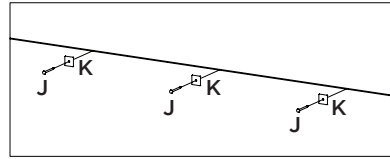
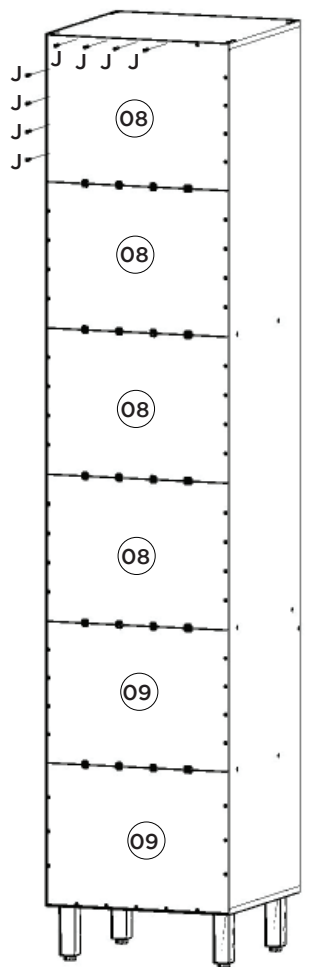

4º

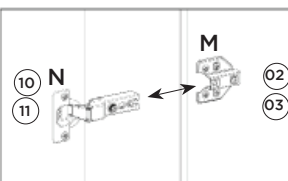
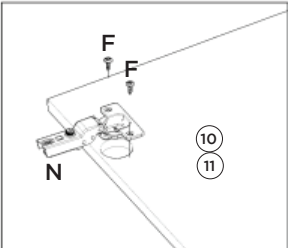
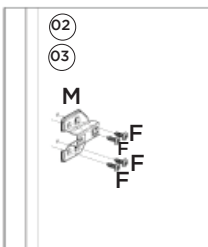

Video: Instalar e regular Dobradiças

Video: Instale y ajuste las bisagras

Video: Install and adjust hinges

5º

- Opção Suspensa
- Opción suspendida
- Suspended Option

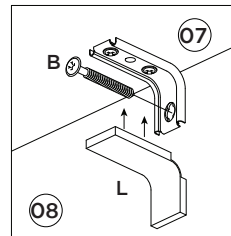
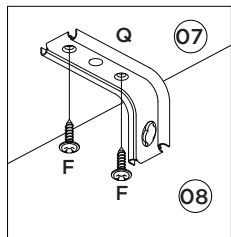
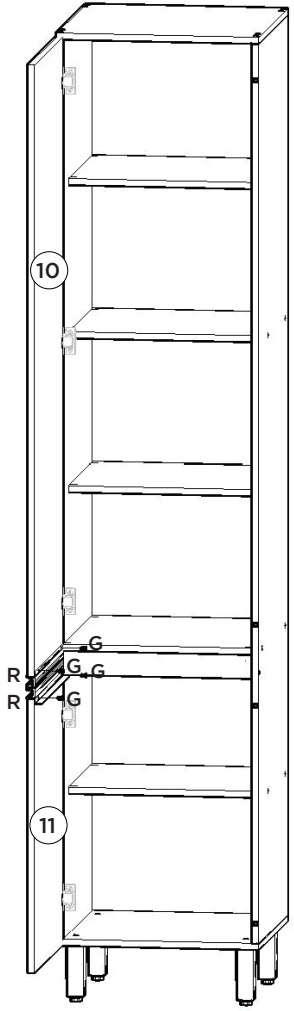

Parede
pared
Wall

