

## Passo / Step / Paso 6:

- FAÇA A MONTAGEM DAS PEÇAS COMO INDICADO ABAIXO, COM SEUS DEVIDOS ACESSÓRIOS.

- ASSEMBLE THE PARTS AS INDICATED BELOW, WITH YOUR DUE ACCESSORIES.

- HACER EL MONTAJE DE LAS PIEZAS COMO INDICADO ABAJO, CON SUS DEBIDOS ACCESORIOS.

<b>C</b> 30 und. Parafuso 3,5x12 CC Phillips Screw 3,5x12 CC Phillips Tornillo 3,5x12 CC Phillips	<b>K</b> 10 und. Caíço Dobradieira Shims Hinge Calzo de la Bisagra
<b>S</b> 05 und. 	<b>O</b> 01 und. Etiqueta Label

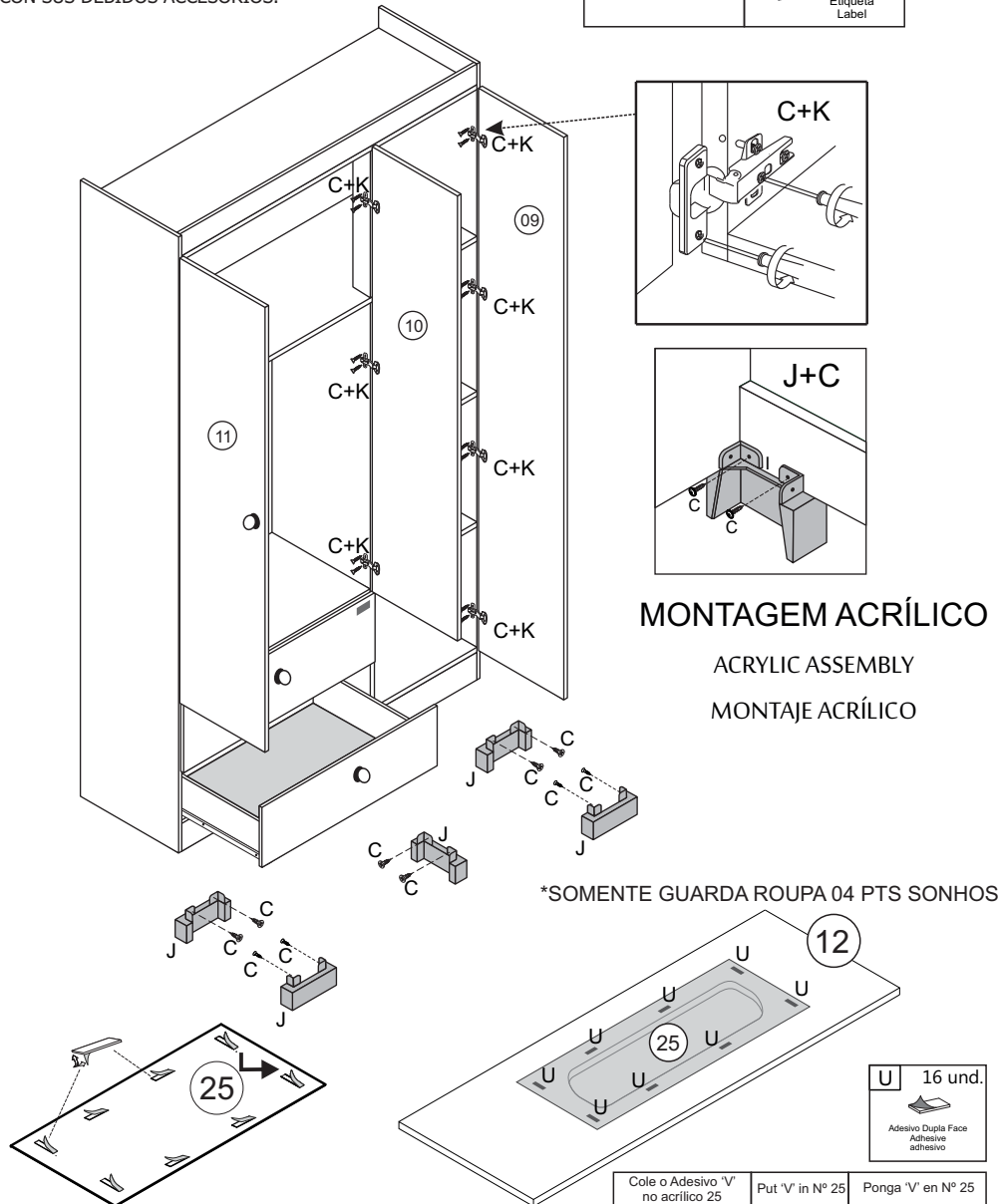

### MONTAGEM ACRÍLICO

ACRYLIC ASSEMBLY

MONTAJE ACRÍLICO

# MANUAL DE INSTRUÇÕES

MANUAL DE INSTRUCCIONES

INSTRUCTION MANUAL



GUARDA ROUPA 3 PTS - CHERRY  
CHERRY WARDROBE 3 DOORS  
ROPERO 3 PUERTAS - CHERRY

GUARDA ROUPA 3 PTS - SONHOS  
SONHOS WARDROBE 3 DOORS  
ROPERO 3 PUERTAS - SONHOS

GUARDA ROUPA 3 PTS - SUPER POWER  
SUPER POWER WARDROBE 3 DOORS  
ROPERO 3 PUERTAS - SUPER POWER

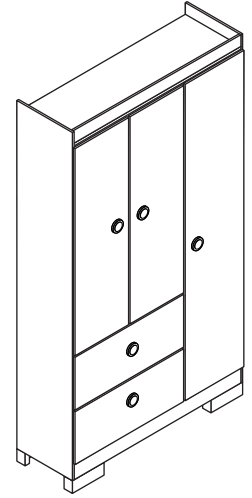
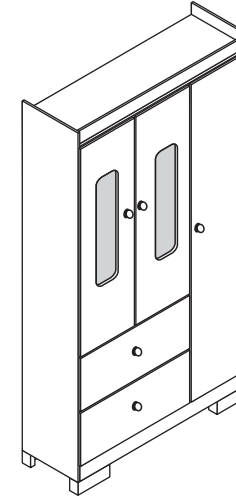
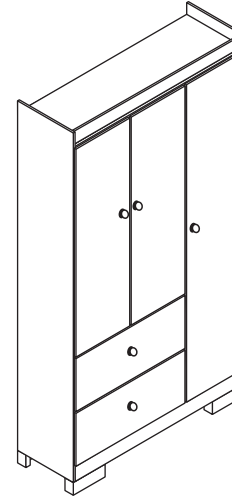

GUARDA ROUPA 3 PTS - FLORESTA ENCANTADA  
FLORESTA ENCANTADA WARDROBE 3 DOORS  
ROPERO 3 PUERTAS - FLORESTA ENCANTADA

GUARDA ROUPA 3 PTS - LILI/TED  
LILI/TED WARDROBE 3 DOORS  
ROPERO 3 PUERTAS - LILI/TED

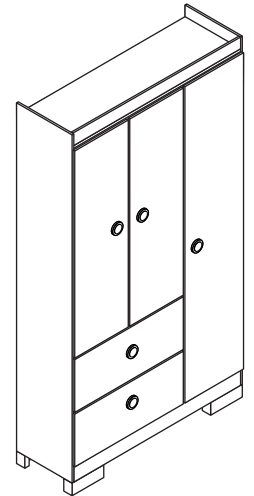
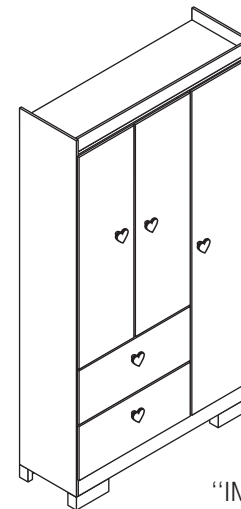

SUA CASA, SEU ESTILO

"IMAGENS MERAMENTE ILUSTRATIVAS,  
SUJEITAS À ALTERAÇÕES SEM PRÉVIO AVISO"



Pessoas Necessárias para montagem

Necessary people for assembly

1 Adulto  
1 Adult  
1 Adulto

Gente necesaria para la asamblea

Ferramentas Necessárias (Não Inclusas)

Tools needed (not included)

Herramientas necesarias (no incluido)



Martelo  
hammer  
martillo



Parafusadeira  
Screwdriver  
destornillador



Chave Fenda  
Slot Key  
Clave de runura



Chave Phillips  
Phillips Key  
Clave Phillips

## INFORMAÇÕES SOBRE SEGURANÇA

1. Esta embalagem contém peças pequenas, mantenha afastada de crianças até que o produto esteja montado.
2. As instruções são genéricas, as figuras podem variar.
3. Leia atentamente todas as instruções antes de iniciar a montagem.
4. Separe e guarde a etiqueta de identificação.
5. Confira se os volumes e quantidades de peças descritos no manual estão corretos.
6. Identifique as peças e separe os acessórios.
7. A montagem do produto deverá ser feita em uma superfície limpa e plana. Aconselhamos utilizar a própria embalagem para forrar o chão a fim de não danificar o produto.
8. Reservar área livre para montagem do produto.
9. Evitar batidas e o contato com objetos cortantes.
10. Não expor o móvel a calor excessivo (luz solar direta), ou umidade elevada.
11. Para limpeza use um pano macio seco ou ligeiramente umedecido com água. Não use agentes de limpeza ou abrasivos.

## SAFETY INFORMATION

1. This package contains small parts, keep away from children until the product is assembled.
2. The instructions are generic, the figures may vary.
3. Read all instructions carefully before starting assembly.
4. Separate and store the ID tag.
5. Check if the volumes and quantities of pieces described in the manual are correct.
6. Identify the pieces and separate accessories.
7. The assembly of the product shall be made on a clean and flat surface. We recommend using the package itself to cover the floor in order not to damage the product.
8. Reserve a specific area to assembly the product.
9. Avoid shocks and contact with sharp objects.
10. Do not expose the furniture to excessive heat (direct sunlight), or high humidity.
11. For cleaning use a dry soft cloth or slightly moistened with water. Do not use cleaning agents or abrasives

## INFORMACIÓN DE SEGURIDAD



1. Este paquete contiene piezas pequeñas, mantenga alejado de los niños hasta que el producto esté montado.
2. Las instrucciones son genéricas, los dibujos pueden variar.
3. Lea todas las instrucciones cuidadosamente antes de empezar el montaje.
4. Separar y almacenar la etiqueta de identificación.
5. Verifique si los volúmenes y cantidades de las piezas descritas en el manual estan correctas.
6. Identificar las piezas y separar los accesorios.
7. El montaje del producto se efectuará sobre una superficie limpia y plana. Se recomienda usar el propio envase para cubrir el suelo con el fin de no dañar el producto.
8. Reserve una área específica para el montaje del producto.
9. Evitar los golpes y el contacto con objetos afilados.
10. No exponga el mueble a un calor excesivo (luz solar directa), o alta humedad.
11. Para la limpieza utilice un paño suave y seco o ligeramente humedecido con agua. No utilice productos de limpieza o abrasivos

## Passo / Step / Paso 5:

- FAÇA A MONTAGEM DAS PEÇAS COMO INDICADO ABAIXO, COM SEUS DEVIDOS ACESSÓRIOS.

- ASSEMBLE THE PARTS AS INDICATED BELOW, WITH YOUR DUE ACCESSORIES.

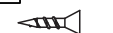
- HACER EL MONTAJE DE LAS PIEZAS COMO INDICADO ABAJO, CON SUS DEBIDOS ACCESORIOS.

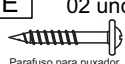
<b>B</b> 08 und.	<b>D</b> 26 und.	<b>I</b> 08 und.
 Parafuso 4,0x40 CC Phillips Screw 4,0x40 CC Phillips Tornillo 4,0x40 CC Phillips	 Parafuso 3,0x20 CC Phillips Screw 3,0x20 CC Phillips Tornillo 3,0x20 CC Phillips	 Parafuso 3,5x10 Franjeado Screw 3,5x10 Franjeado Tornillo 3,5x10 Franjeado
<b>T</b> 02 und.		<b>E</b> 02 und.
 Puxador Handle Tirador		 Parafuso para puxador Screw puller Tornillo arrancador

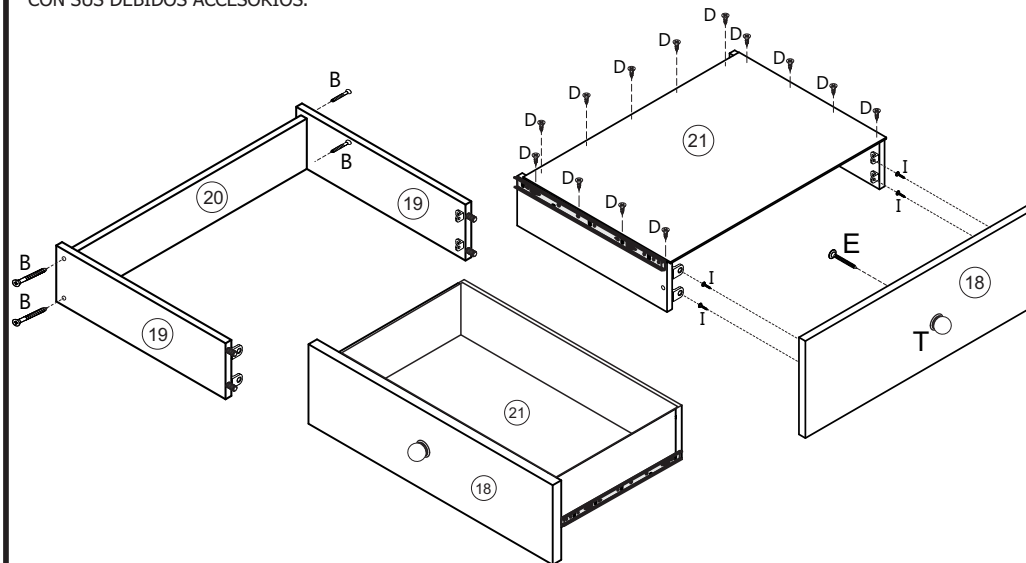

PESO suportado / DIMENSÕES PRODUTO MONTADO  
SUPPORTED WEIGHT / DIMENSIONS ASSEMBLED PRODUCT  
PESO SOPORTADO / DIMENSIONES PRODUCTO ARMADO

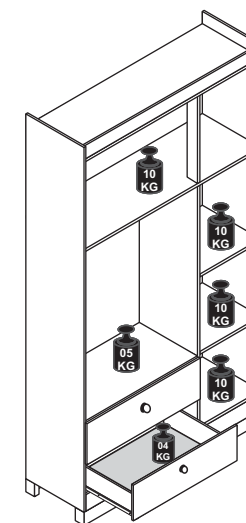
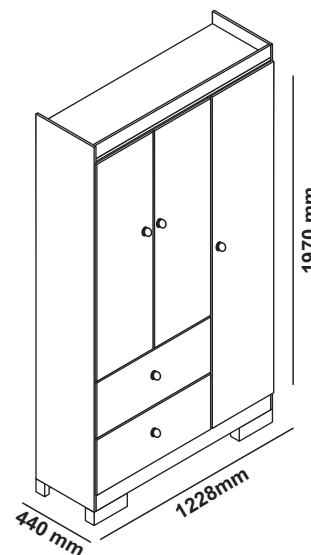

## Passo / Step / Paso 4:

- FAÇA A MONTAGEM DAS PEÇAS COMO INDICADO ABAIXO, COM SEUS DEVIDOS ACESSÓRIOS.

- ASSEMBLE THE PARTS AS INDICATED BELOW, WITH YOUR DUE ACCESSORIES.

- HACER EL MONTAJE DE LAS PIEZAS COMO INDICADO ABAJO, CON SUS DEBIDOS ACCESORIOS.



<b>C</b>	02 und.
	Parafuso 3,5x12 CC Philips Screw 3,5x12 CC Philips Tornillo 3,5x12 CC Philips
<b>H</b>	01 und.
	Alça de segurança Security tape Cinta de seguridad
<b>L</b>	01 und.
	Buxa ivasa 8mm
<b>P</b>	01 und.
	Perfil H 445mm
<b>Z</b>	01 und.
	Perfil H 427mm
<b>Y</b>	01 und.
	Perfil H 1345mm
<b>M</b>	10 und.
	Chapa União Fundo Insulation Pins Chapa prendedora
<b>F</b>	51 und.
	Prego 8x8 Nail 8x8 Clavo 8x8
<b>A</b>	01 und.
	Parafuso 5,0x50 CC Philips Screw 5,0x50 CC Philips Tornillo 5,0x50 CC Philips

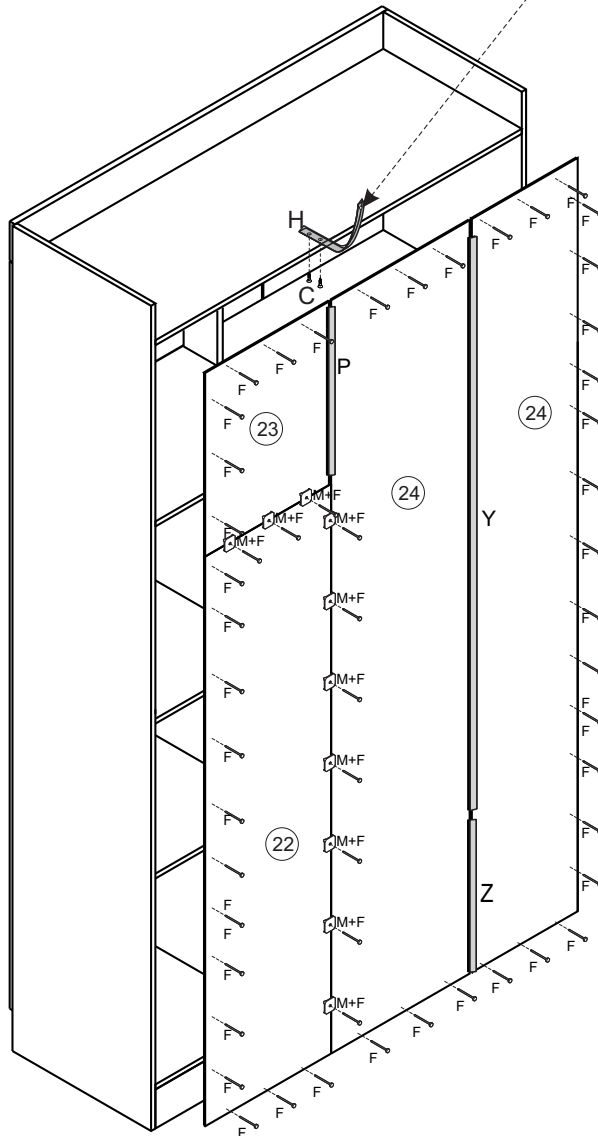

10

## Passo / Step / Paso 6:

GUARDA ROUPA 3 PTS - CHERRY  
CHERRY WARDROBE 3 DOORS  
ROPERO 3 PUERTAS - CHERRY

GUARDA ROUPA 3 PTS - SUPER POWER  
SUPER POWER WARDROBE 3 DOORS  
ROPERO 3 PUERTAS - SUPER POWER

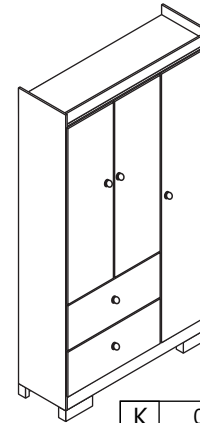

GUARDA ROUPA 3 PTS - SONHOS  
SONHOS WARDROBE 3 DOORS  
ROPERO 3 PUERTAS - SONHOS

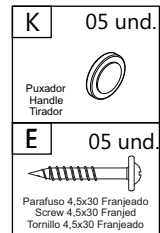
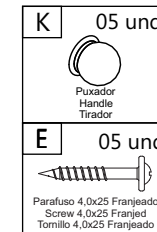
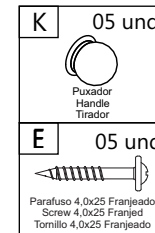
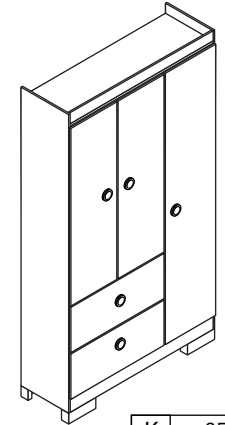

GUARDA ROUPA 3 PTS - FLORESTA ENCANTADA  
FLORESTA ENCANTADA WARDROBE 3 DOORS  
ROPERO 3 PUERTAS - FLORESTA ENCANTADA

GUARDA ROUPA 3 PTS - URSINHO  
URSINHO WARDROBE 3 DOORS  
ROPERO 3 PUERTAS - URSINHO

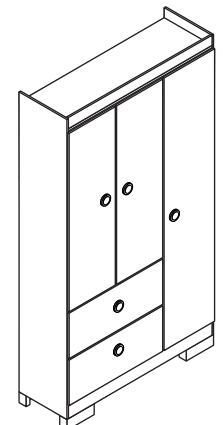
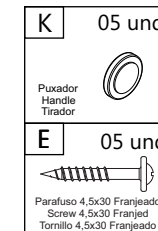
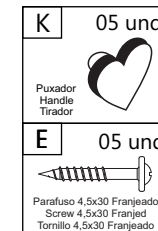
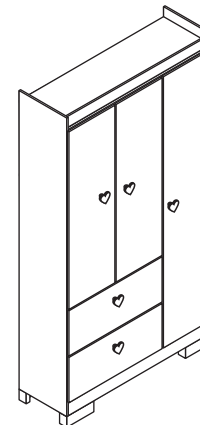

12

03

IDENTIFICAÇÃO DAS PEÇAS / IDENTIFICATION OF PARTS / IDENTIFICACIÓN DE LAS PIEZAS

\*AS PORTAS CENTRAIS SÃO TEMÁTICAS E POSSUEM A MESMA NUMERAÇÃO, ALTERANDO A USINAGEM CONFORME MODELO ESCOLHIDO.

CÓD.	IDENTIFICAÇÃO DAS PEÇAS	IDENTIFICATION OF PARTS	IDENTIFICACIÓN DE LAS PIEZAS	QTD
01	Lateral Direita	Right Side	Lateral Derecha	1
02	Lateral Esquerda	Left Side	Lateral Izquierda	1
03	Divisoria	Division	Partición	1
04	Chapéu	Shelf	Tampo	1
05	Base do Maleiro	Luggage storage base	Base de depósito de equipajes	1
06	Tampo do Gaveteiro	Drawers top	Superior Cajón	1
07	Prateleira	Shelf	Estante	2
08	Base	Bottom Board	Tampo Inferior	1
09	Porta Lateral	Side door	Puerta Lateral	1
10	Porta do Meio Direita	Central Door Right	Puerta Central Derecha	1
11	Porta do Meio Esquerda	Central Door Left	Puerta Central Izquierda	1
12	Porta do Meio (Vazada)	Central Door VAZADA	Central Puerta VAZADA	2
13	Rodateto	Wheel ceiling	Rodateto	1
14	Rodape Frontal	Front Baseboard	Rodapie Frontal	1
15	Rodapé Traseiro	Back Baseboard	Rodapie Trasero	1
16	Rodapé Central	Lock Bar	Bloqueo	1
17	Batente	Jamb Stop	Batente	1
18	Frente de Gaveta	Drawer Front	Frente del Cajón	2
19	Lateral de Gaveta	Drawer Side	Lado del cajón	4
20	Contra Fundo	Drawer Back	Trasera del cajón	2
21	Fundo da Gaveta	Drawer Bottom	Fondo del Cajón	2
22	Fundo Lateral Inferior	Lower side back	Fondo Lateral Inferior	1
23	Fundo Lateral Superior	Higfer side back	Fondo Lateral Superior	1
24	Fundo Traseiro	Back Bottom	Fondo Trasero	2
25	Acrílico	Acrylic	Acrílico	2

**ASSISTÊNCIA TÉCNICA**

As solicitar assistência técnica, informe o número da peça, nome, cor do produto e a data de fabricação do lote que se encontra carimbado na peça N° 23.

**TECHNICAL ASSISTANCE**

When request the technical assistance, inform the number of the piece name and color of the product and also the batch manufacturing date, that is stamped on the piece n° 23.

**ASISTENCIA TÉCNICA**

Al solicitar la asistencia técnica, informe el número de la pieza, el nombre y el color del producto y también la fecha de fabricación del lote, que se estampa en la pieza n° 23.



Passo / Step / Paso 3:

- FAÇA A MONTAGEM DAS PEÇAS COMO INDICADO ABAIXO, COM SEUS DEVIDOS ACESSÓRIOS.

- ASSEMBLE THE PARTS AS INDICATED BELOW, WITH YOUR DUE ACCESSORIES.

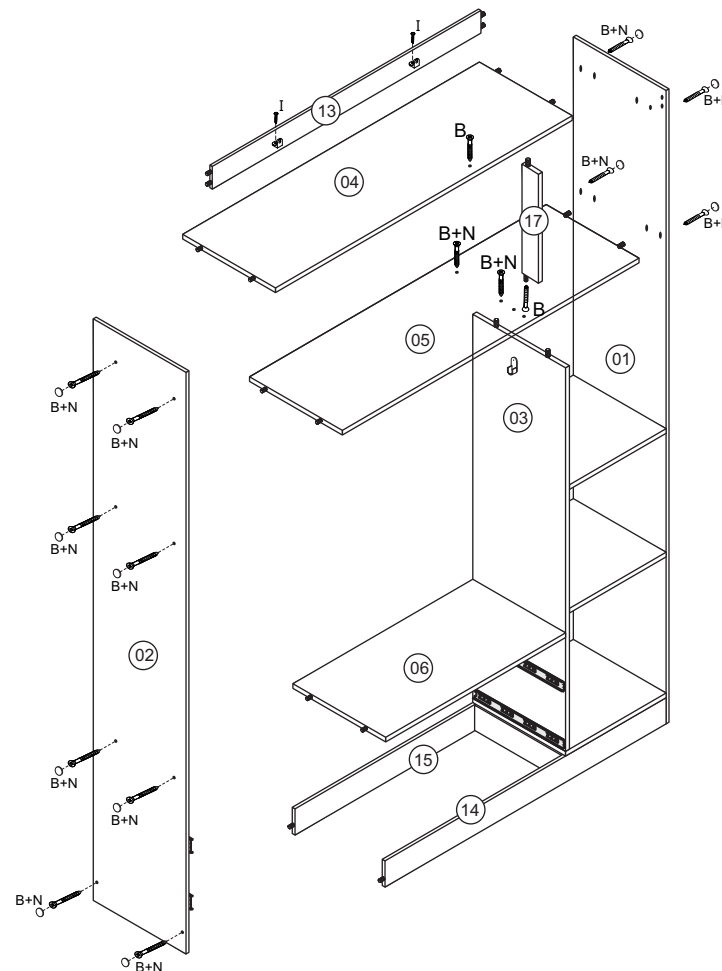
- HACER EL MONTAJE DE LAS PIEZAS COMO INDICADO ABAJO, CON SUS DEBIDOS ACCESORIOS.





<b>I</b>	02 und.	<b>B</b>	16 und.	<b>N</b>	14 und.
 Parafuso 3,5x10 Franjeado Screw 3,5x10 Franjeado Tornillo 3,5x10 Franjeado		 Parafuso 4,0x40 CC Philips Screw 4,0x40 CC Philips Tornillo 4,0x40 CC Philips		 Tampa Adesiva 18 mm Adhesive label 18mm Tapa adhesiva 18mm	

## Passo / Step / Paso 2:

- FAÇA A MONTAGEM DAS PEÇAS COMO INDICADO ABAIXO, COM SEUS DEVIDOS ACESSÓRIOS.

- ASSEMBLE THE PARTS AS INDICATED BELOW, WITH YOUR DUE ACCESSORIES.

- HACER EL MONTAJE DE LAS PIEZAS COMO INDICADO ABAJO, CON SUS DEBIDOS ACCESORIOS.

B	18 und.	I	04 und.	N	14 und.
					
Parafuso 4,0x40 CC Philips Screw 4,0x40 CC Philips Tornillo 4,0x40 CC Philips		Parafuso 3,5x10 Franjeado Screw 3,5x10 Franjeado Tornillo 3,5x10 Franjeado		Tampa Adesiva 18 mm Adhesive label 18mm Tapa adhesiva 18mm	

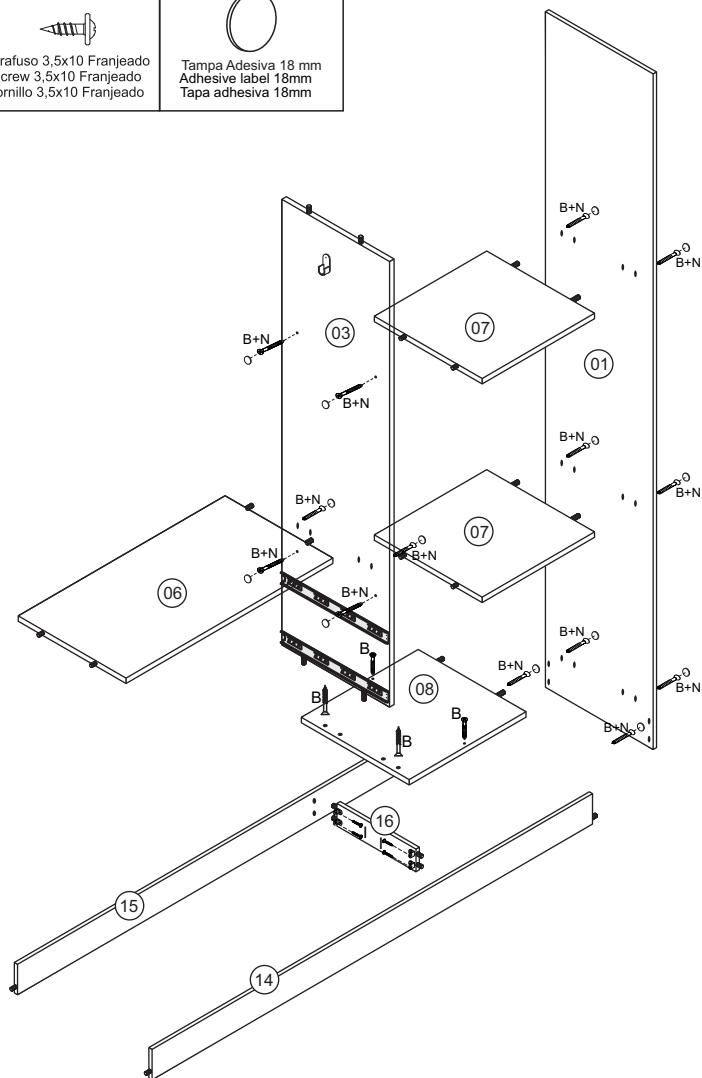

08

## IDENTIFICAÇÃO DAS PEÇAS

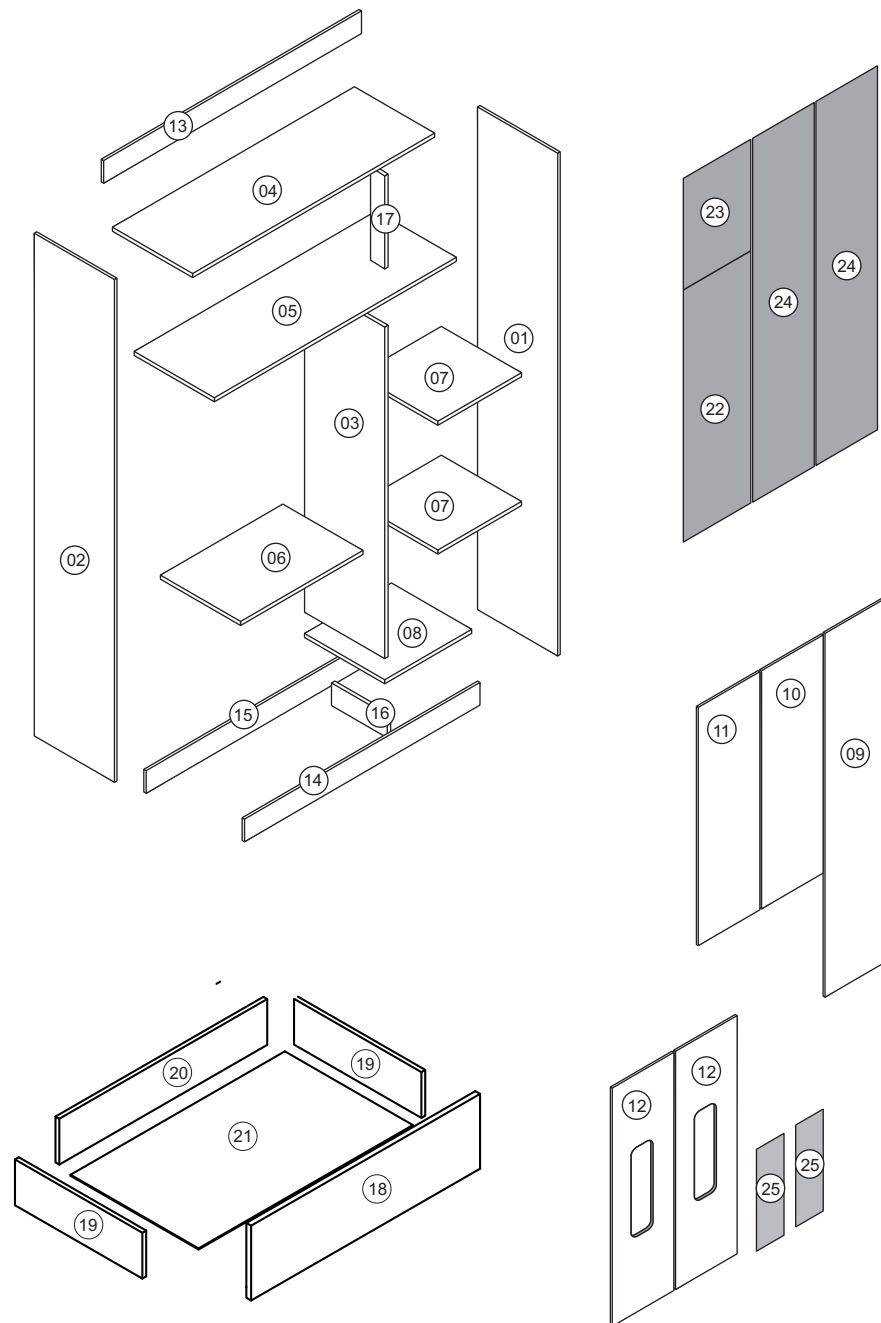

05



1 Adulto  
1 Adult  
1 Adulto

Pessoas Necessárias  
para montagem

Necessary people  
for assembly

Gente necesaria  
para la asamblea

Ferramentas Necessárias (Não Inclusas)

Tools needed (not included)

Herramientas necesarias (no incluido)



Martelo  
hammer  
martillo



Parafusadeira  
Screwdriver  
destornillador

















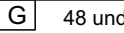
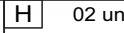
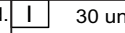

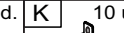
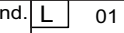
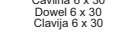

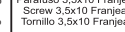
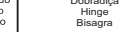
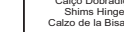
Chave Fenda  
Slot Key  
Clave de runura



Chave Phillips  
Phillips Key  
Clave Phillips

## FERRAGENS / IRONMONGERY / HERRAJES

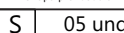
<b>A</b> 01 und.	<b>B</b> 40 und.	<b>C</b> 76 und.	<b>D</b> 26 und.	<b>E</b> 05 und.	<b>F</b> 51 und.
 Parafuso 5,0x50 CC Philips Screw 5,0x50 CC Philips Tornillo 5,0x50 CC Philips	 Parafuso 4,0x40 CC Philips Screw 4,0x40 CC Philips Tornillo 4,0x40 CC Philips	 Parafuso 3,5x12 CC Philips Screw 3,5x12 CC Philips Tornillo 3,5x12 CC Philips	 Parafuso 3,0x20 CC Philips Screw 3,0x20 CC Philips Tornillo 3,0x20 CC Philips	 Parafuso 4,0x25 Franjeado Screw 4,0x25 Franjeado Tornillo 4,0x25 Franjeado	 Prego 8x8 Nail 8x8 Clavo 8x8
<b>G</b> 48 und.	<b>H</b> 02 und.	<b>I</b> 30 und.	<b>J</b> 10 und.	<b>K</b> 10 und.	<b>L</b> 01 und.
 Cavilha 6 x 30 Dowel 6 x 30 Clavija 6 x 30	 Suporte Bastão Cabideiro Plastic Bar Support Soporte Barra de Plastico	 Parafuso 3,5x10 Franjeado Screw 3,5x10 Franjeado Tornillo 3,5x10 Franjeado	 Dobradica Hinge Bisagra	 Calço Dobradica Shim Hinge Calzo de la Bisagra	 Buxa ivasa 8mm
<b>M</b> 10 und.	<b>N</b> 25 und.	<b>O</b> 01 und.	<b>P</b> 01 und.	<b>Q</b> 02 und.	<b>R</b> 14 und.
 Chapa União Fundo Insulation Pins Chapa prendedora	 Tampa Adesiva 12mm Adhesive label Tapa adhesiva 12mm	 Etiqueta Label	 Perfil H 445mm	 Corredica 350 mm Sliding rails 350 mm Rieles 350 mm	 Cantoneira 'L' Corner Brace 'L' Abrazadeira 'L'
<b>S</b> 05 und.	<b>T</b> 05 und.	<b>U</b> 16 und.	<b>V</b> 01 und.	<b>W</b> 01 und.	<b>Y</b> 01 und.
 Pé plástico	 Puxador Handle Tirador	 Adesivo Dupla Face Adhesive adhesivo	 Alça de segurança Security tape Cinta de seguridad	 Bastão Cabideiro 590mm Hanging Rail 590mm Perchero 590mm	 Perfil H 1345mm
<b>Z</b> 01 und.					
 Perfil H 427mm					

FERRAGENS ESCALA REAL / REAL SCALE IRONMONGERY / HERRAJES EN TAMAÑO COMPLETO

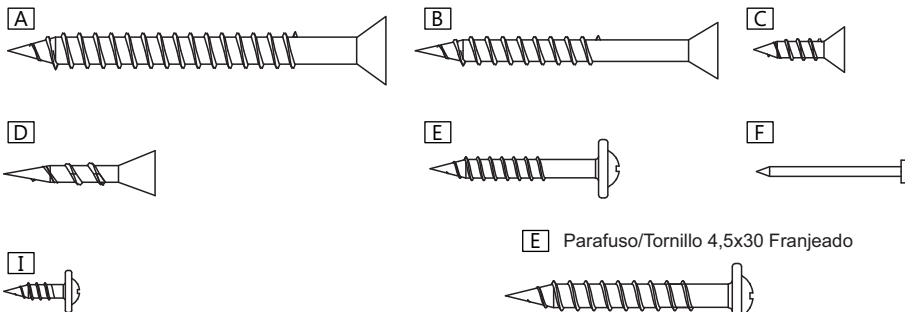

**E** Parafuso/Tornillo 4,5x30 Franjeado

Parafuso utilizado nos  
demais modelos de cômodas

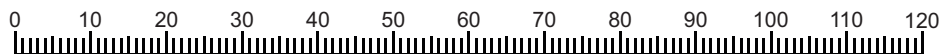

Medidas em mm

## MONTAGEM DO PRODUTO / PRODUCT ASSEMBLY / MONTAJE DEL PRODUCTO





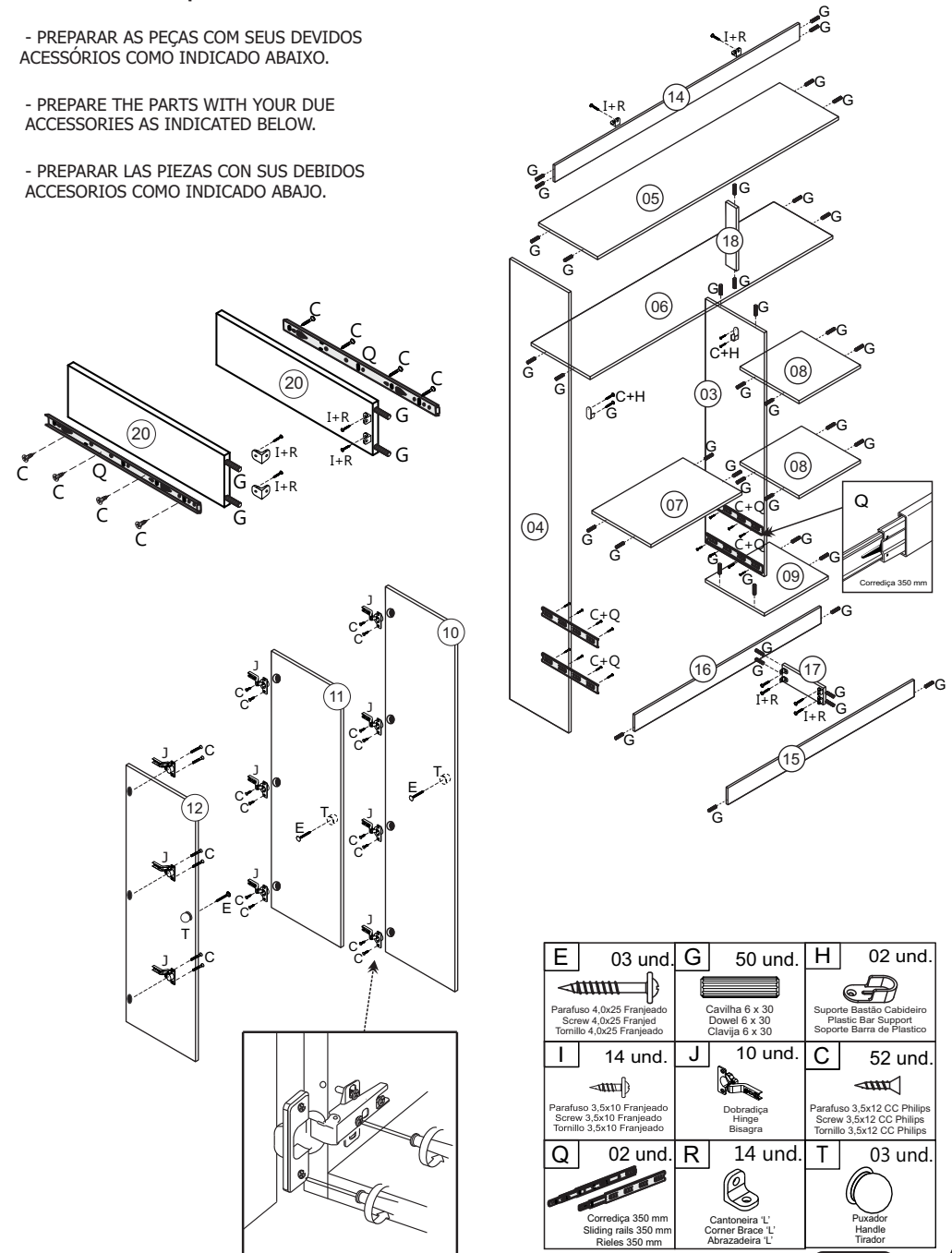

### Passo / Step / Paso 1:

- PREPARAR AS PEÇAS COM SEUS DEVIDOS  
ACESSÓRIOS COMO INDICADO ABAIXO.

- PREPARE THE PARTS WITH YOUR DUE  
ACCESSORIES AS INDICATED BELOW.

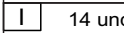
- PREPARAR LAS PIEZAS CON SUS DEBIDOS  
ACCESORIOS COMO INDICADO ABAJO.

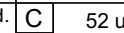
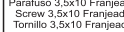
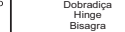

<b>E</b> 03 und.	<b>G</b> 50 und.	<b>H</b> 02 und.
 Parafuso 4,0x25 Franjeado Screw 4,0x25 Franjeado Tornillo 4,0x25 Franjeado	 Cavilha 6 x 30 Dowel 6 x 30 Clavija 6 x 30	 Suporte Bastão Cabideiro Plastic Bar Support Soporte Barra de Plastico
<b>I</b> 14 und.	<b>J</b> 10 und.	<b>C</b> 52 und.
 Parafuso 3,5x10 Franjeado Screw 3,5x10 Franjeado Tornillo 3,5x10 Franjeado	 Dobradica Hinge Bisagra	 Parafuso 3,5x12 CC Philips Screw 3,5x12 CC Philips Tornillo 3,5x12 CC Philips
<b>Q</b> 02 und.	<b>R</b> 14 und.	<b>T</b> 03 und.
 Corredica 350 mm Sliding rails 350 mm Rieles 350 mm	 Cantoneira 'L' Corner Brace 'L' Abrazadeira 'L'	 Puxador Handle Tirador