

MÓDULO SAPATEIRA 682MM DV

ESQUEMA
DE MONTAGEM
949208-01



90 minutos
90 minutes



AVISO !

Para limpeza de seu Móvel:

- Use uma flanela seca ou levemente umedecida.
- Não use produtos químicos.

santos
Andirá

ISO 9001 | 14001

157322 - CASTANHA/CASTANHA
157327 - CASTANHA/OFF WHITE
157422 - CASTANHA/CASTANHA

www.santosandira.com.br

AVISO
*Para limpeza do seu móvel utilize flanela seca ou levemente umidecida, sem produtos químicos!
A montagem é de responsabilidade da loja/site revendedor.*



ISO 14001



ISO 9001







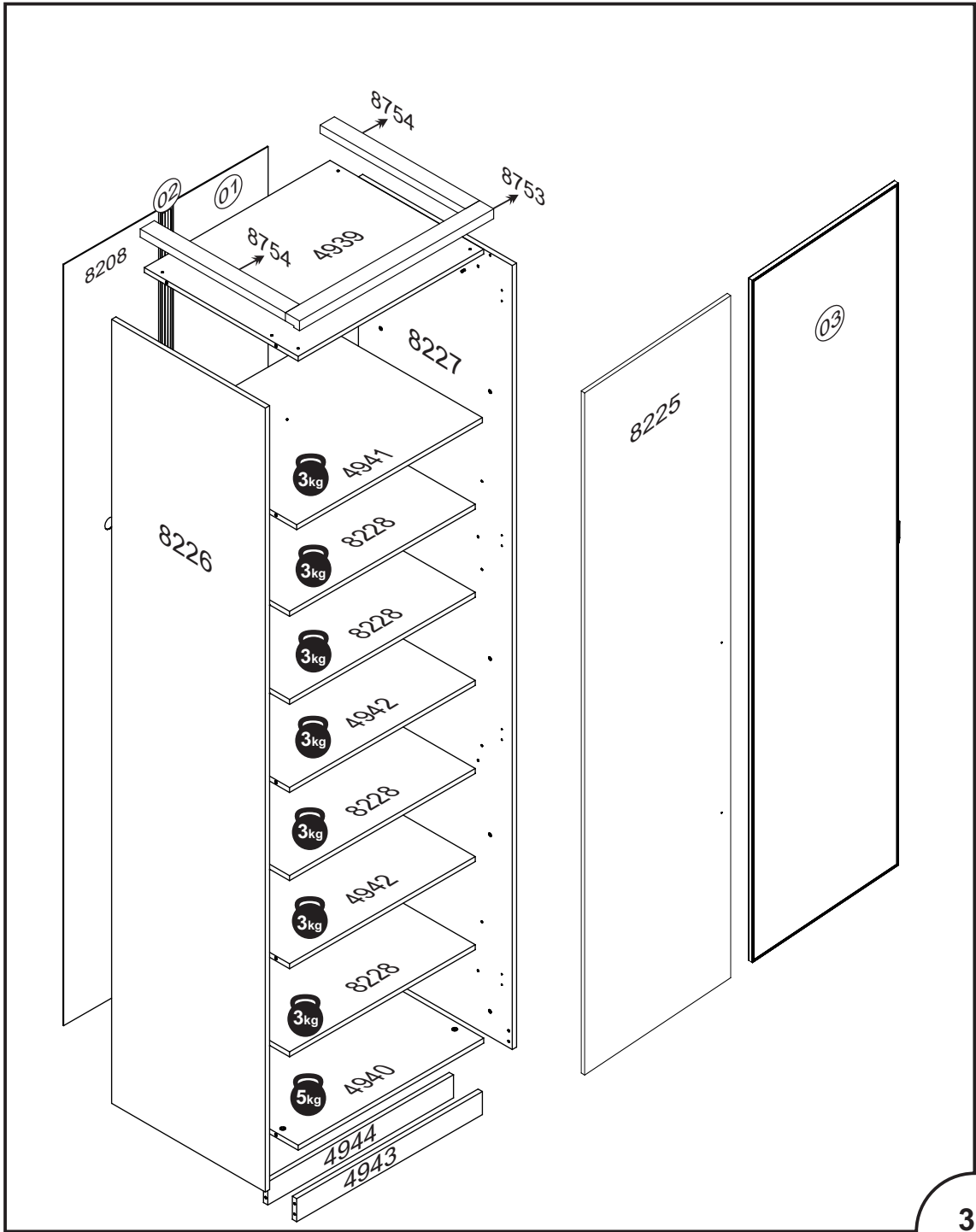







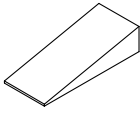

Descarte os resíduos de forma seletiva!

“Para descarte desse móvel, recomendamos que realize doações a instituições, ou procure coletas municipais, empresas especializadas em reciclagem.”

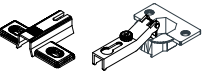

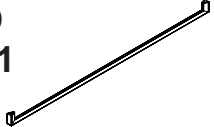
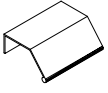
RELAÇÃO DE ACESSÓRIOS

A 08 	B 04 	C 60 	D 20 
CAVILHA MADEIRA 6x25	PREGO 12x12	PREGO 10x10	CASTANHA GIROFIX 15x12
E 20 	F 16 	G 12 	H 04 
PINO GIROFIX 35mm	BUCHA GIROFIX 9mm	TAMPA GIROFIX	SAPATA REDONDA 14mm
I 32 	J 04 	K 08 	L 04 
PARAFUSO FI CH PH 4.0 x 14	CUNHA	TAPA FURO 6mm	PARAFUSO UNIÃO
M 04 	N 06 	O 01 	P 01 
DOBRADIÇA METAL BOX 35mm C/CALCO	PARAFUSO FI CH PH 4.5x30	PUXADOR 576mm COM PARAFUSO	PUXADOR RX 55mm PARA PORTA C/ ESPELHO C/ FITA
Q 16 	R 01 		
SUPORTE DE PRATELEIRA	TAMPA RESPIRO		

RELAÇÃO DE PEÇAS

DESCRIÇÃO	VOLUME	NÚMERO	DIMENSÃO	QUANTIDADE
TRASEIRO	01	01	2315x333x2,5	01
PERFIL H30	01	02	2285mm	01
CHAPEU	01	4939	652x540x15	01
BASE INFERIOR	01	4940	652x540x15	01
BASE DO MALEIRO	01	4941	652x530x15	01
TRASEIRO C/ FURO	01	8208	2315x333x2,5	01
LAT. EXT. ESQUERDA	01	8226	2385x540x15	01
LAT. EXT. DIREITA	01	8227	2385x540x15	01
DESCRIÇÃO	VOLUME	NÚMERO	DIMENSÃO	QUANTIDADE
PORTA	02	8225	2310x660x15	01
DESCRIÇÃO	VOLUME	NÚMERO	DIMENSÃO	QUANTIDADE
PORTA C/ ESPELHO	02	02	2310x660x15	01
DESCRIÇÃO	VOLUME	NÚMERO	DIMENSÃO	QUANTIDADE
TAMPO	03	4942	652x505x15	02
RODAPÉ FRONTAL	03	4943	652x70x15	01
RODAPÉ TRASEIRO	03	4944	652x70x15	01
PRATELEIRA MÓVEL	03	8228	652x505x15	04
VISTA FRONTAL	03	8753	682x50x25	01
VISTA LATERAL	03	8754	510x50x18	02

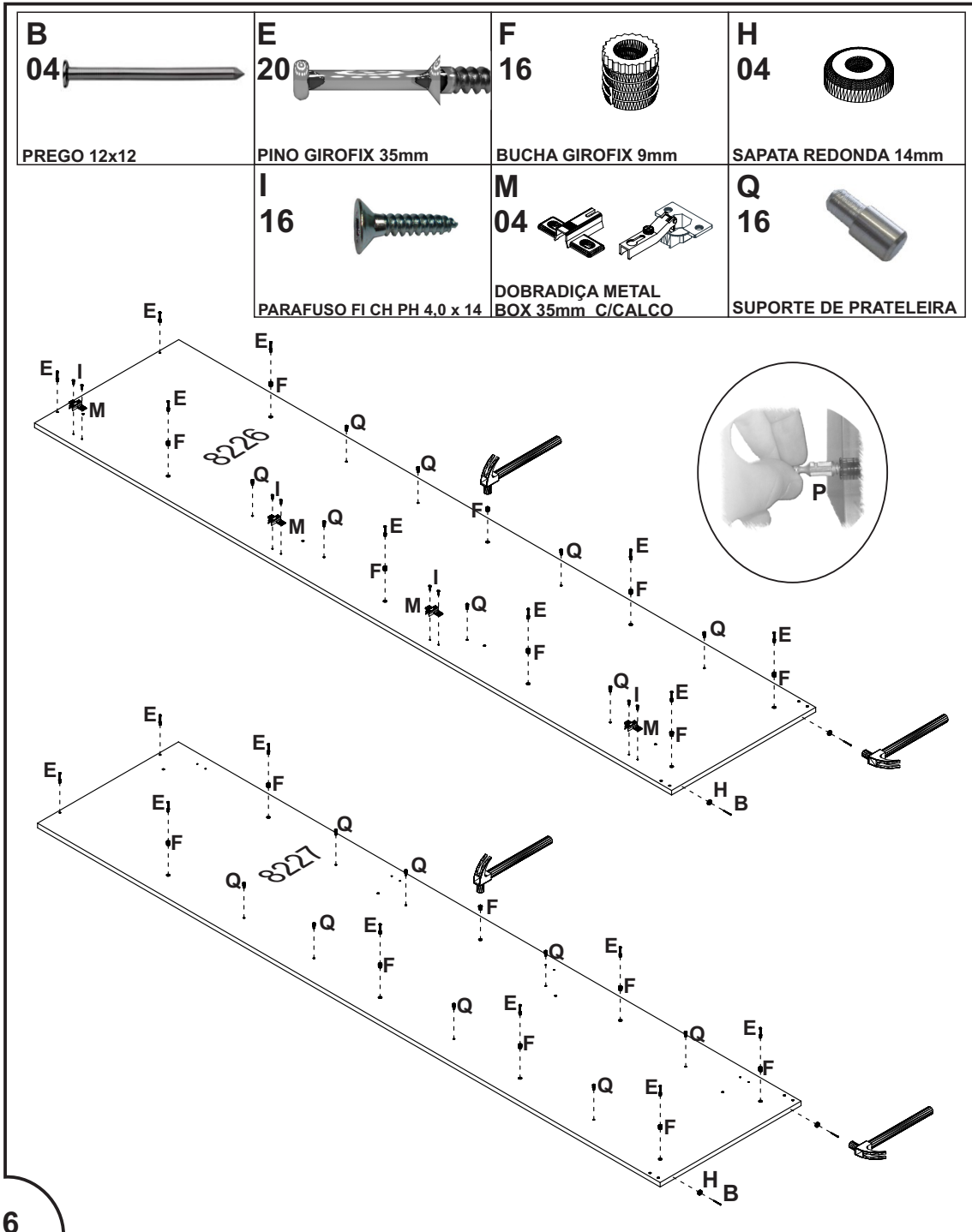

A
08



CAVILHA MADEIRA 6x25

D
20



CASTANHA GIROFIX 15x12

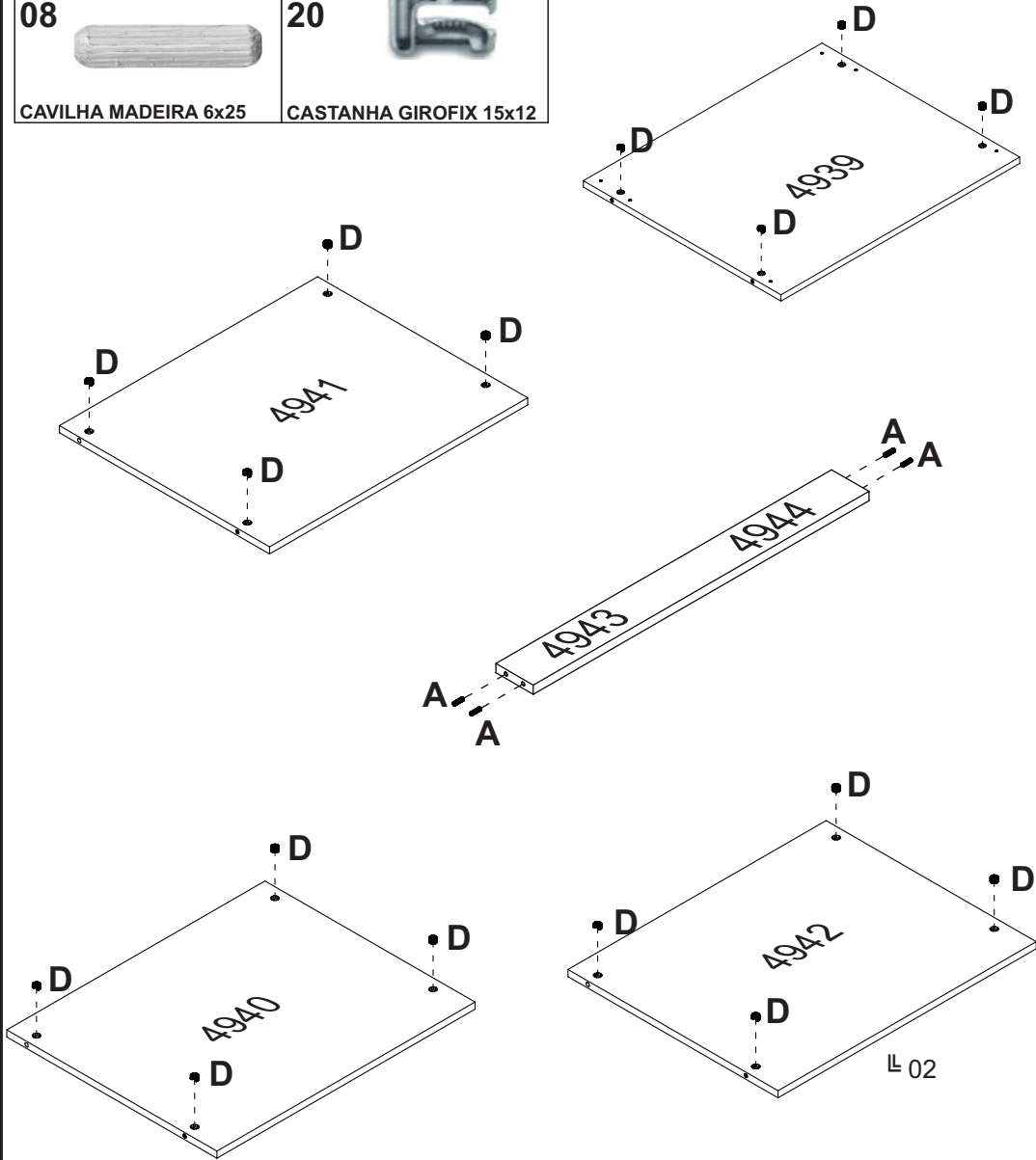

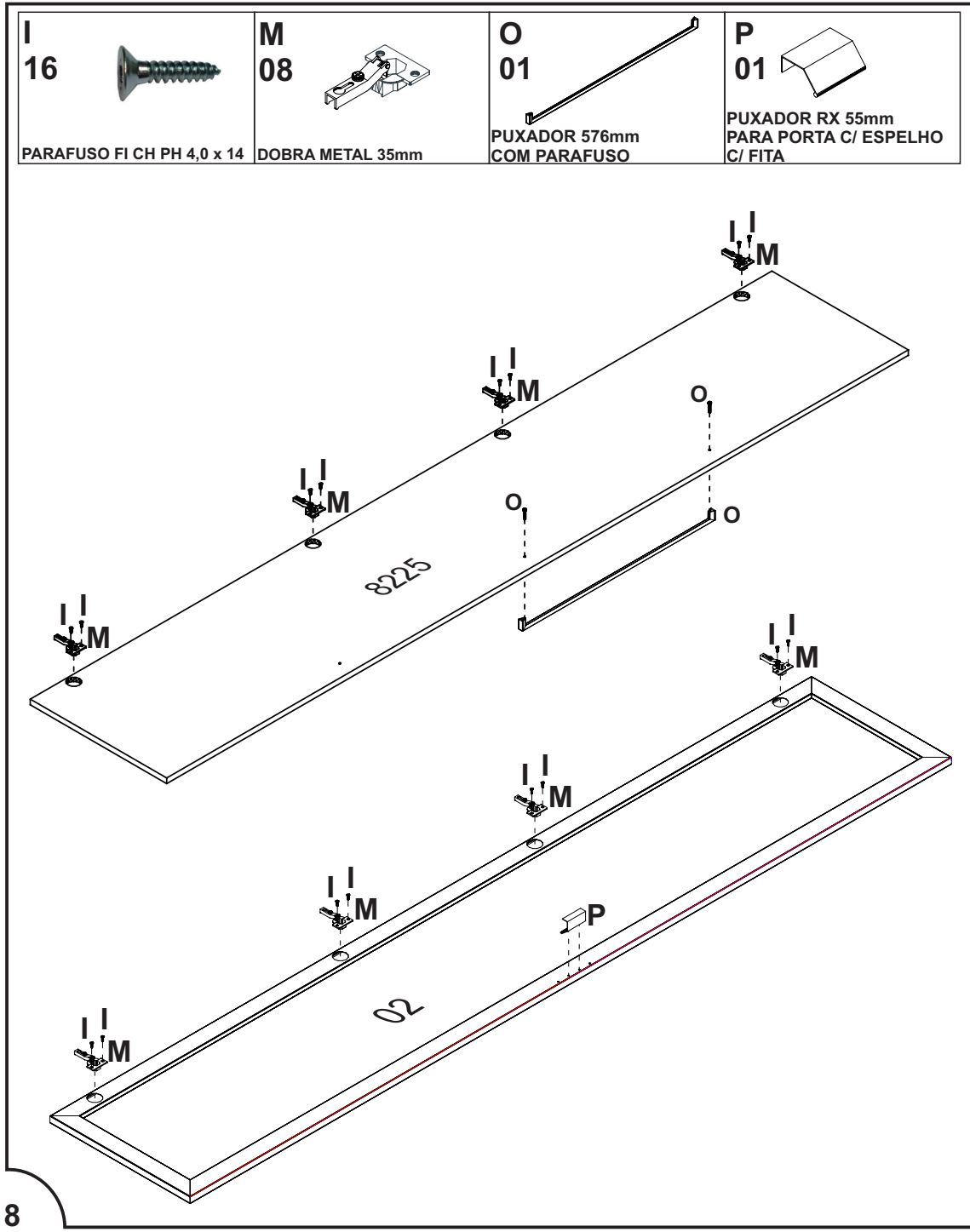

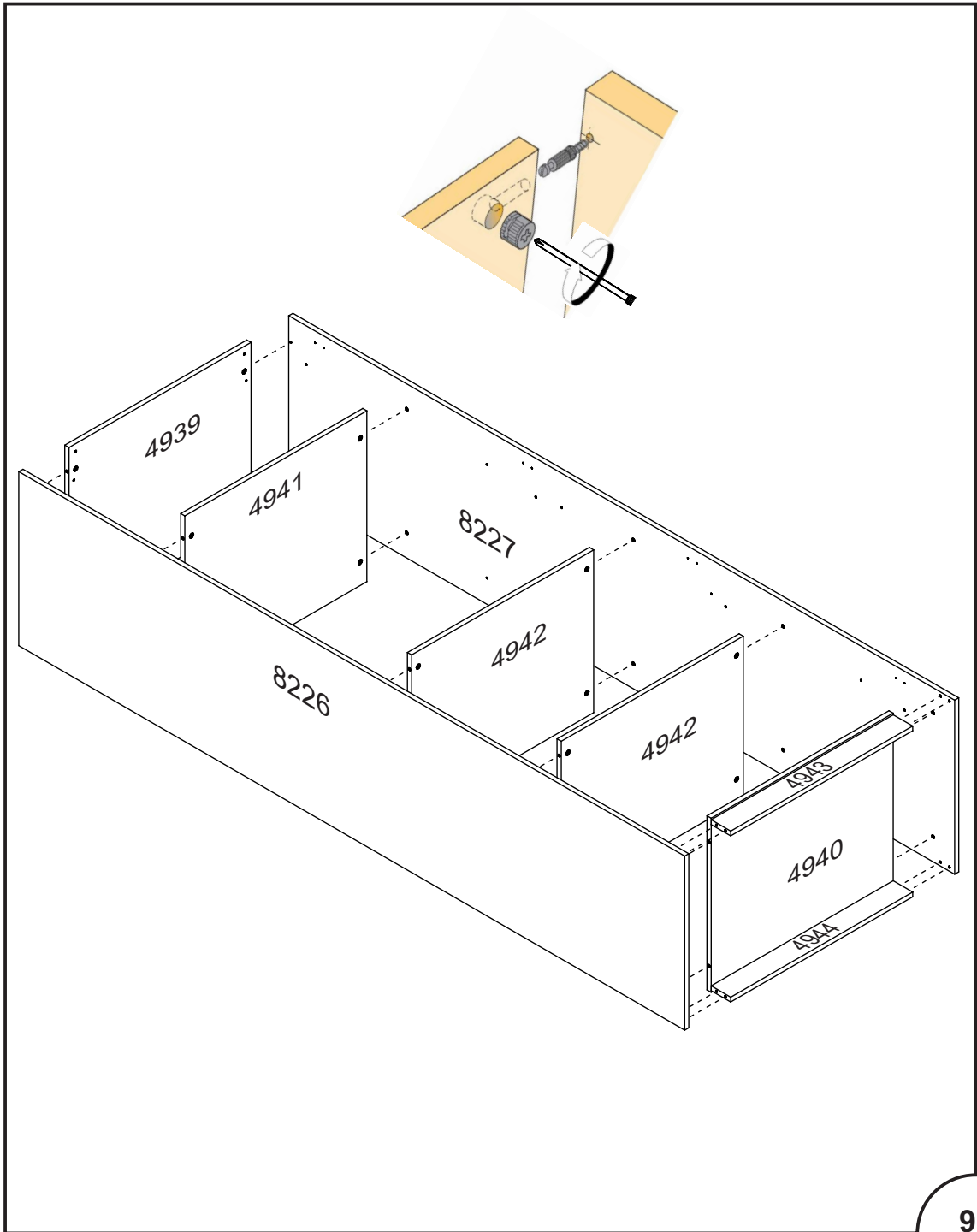

C
60



PREGO 10x10

R
01



TAMPA RESPIRO

M

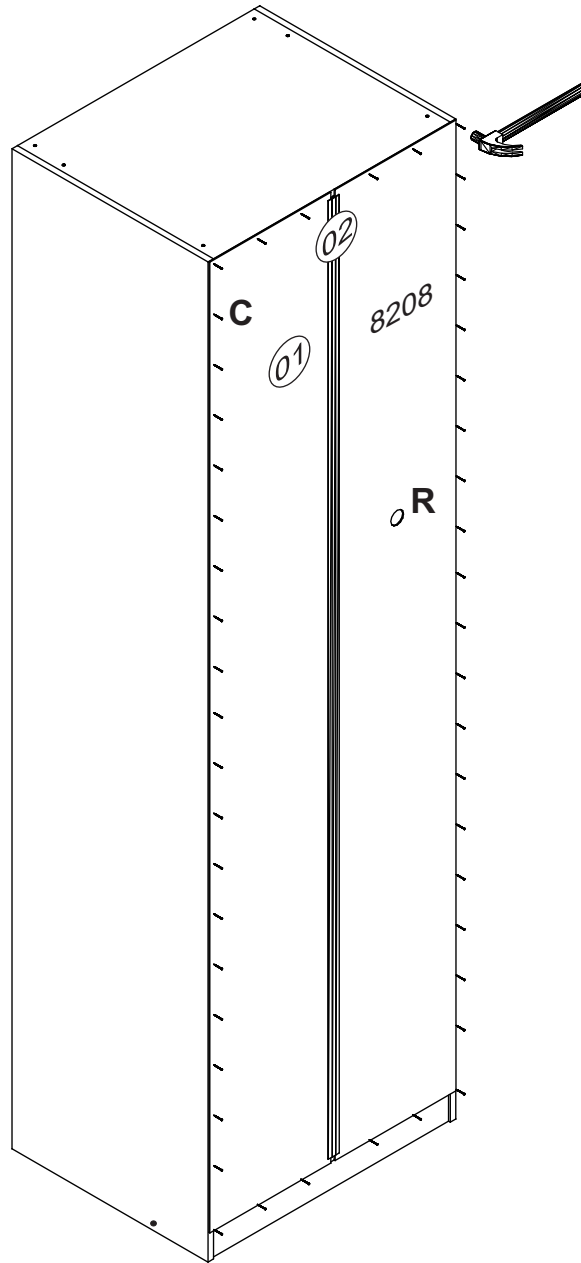

Obs:
Fixar os pregos a (100mm)
de distância de um para outro.

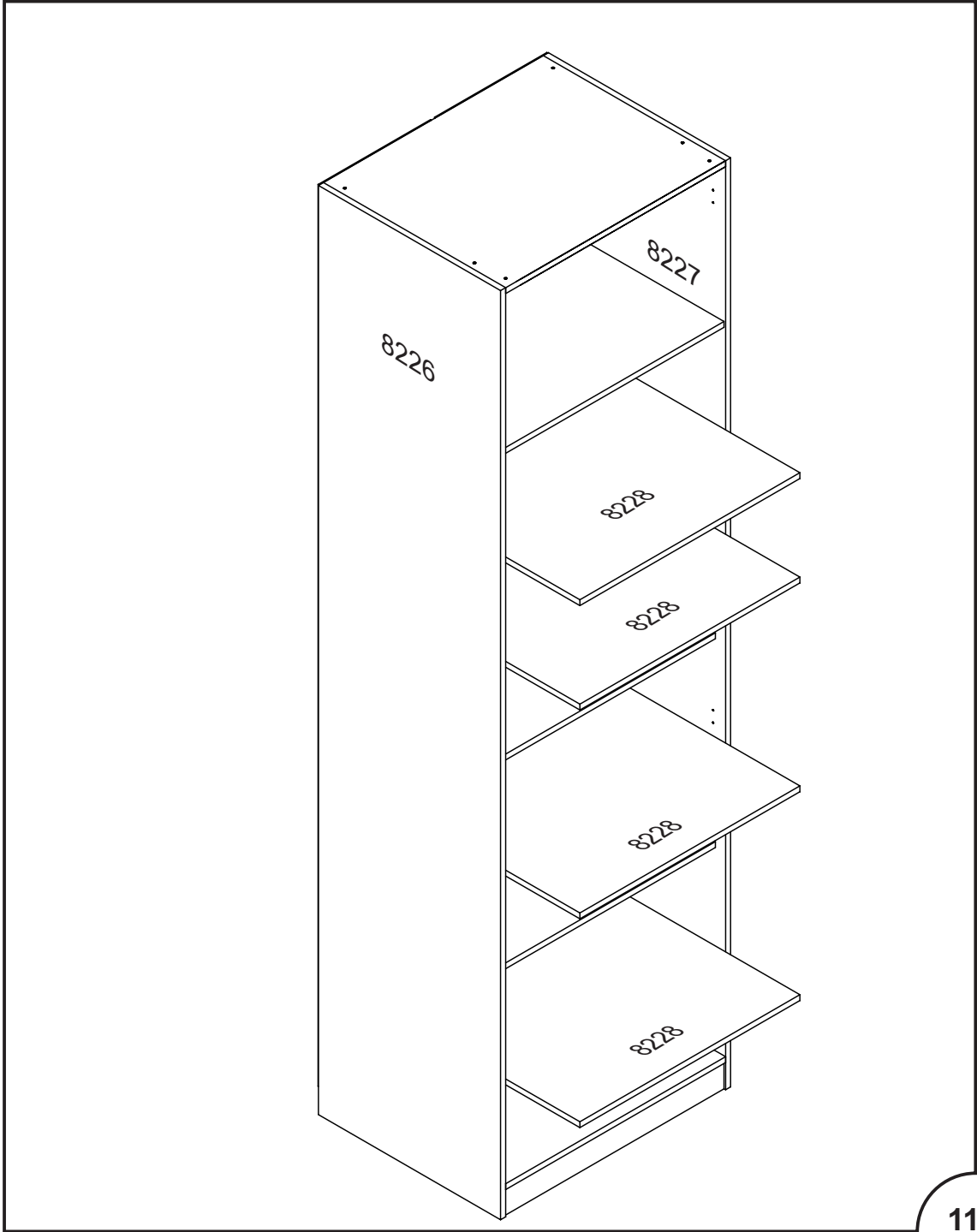

N
06 
PARAFUSO FI CH PH 4,5x30

