

# Suporte para TV

FIXO: LCD / LED  
PLASMA / 3D

## INFINITI

### ATENÇÃO

1. Ler e observar atentamente toda a instrução antes de iniciar a montagem.
2. A montagem do produto deverá ser feita em uma superfície limpa e plana.
3. Evitar batidas e o contato com objetos cortantes.
4. Observar a carga máxima suportável.



CARGA MÁXIMA

100 kg

Pessoas necessárias para montagem



2 pessoas

Ferramentas necessárias (Não fornecidas)



Chave Phillips



Furadeira com broca de 8mm

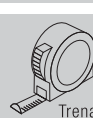

Trena

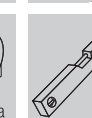

Nível



Chave 11 mm

### LIMPEZA

1. Pano levemente umedecido com água, seguido de pano seco.
2. Não utilizar produtos químicos ou abrasivos.

SAC 11 4158 8700 www.multivisao.com.br e-mail: sac@multivisao.com.br

## COMPONENTES

ID QNT DESCRIÇÃO

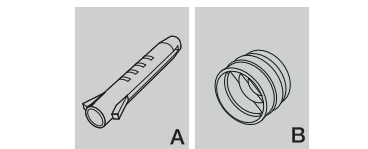

A 5 BUCHA 8MM

B 2 BUCHA CARRETEL

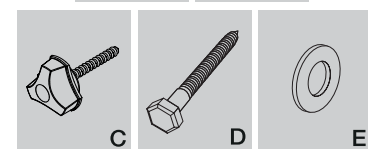

C 1 NIVELADOR

D 4 PARAFUSO 1/4 x 45

E 2 ARRUELA LISA 1/4

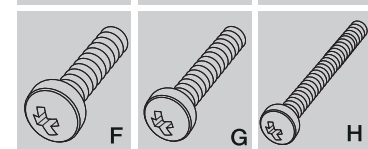

F 2 PARAFUSO M8 x 25

G 2 PARAFUSO M6 x 25

H 2 PARAFUSO M4 x 25

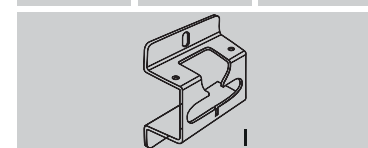

I 2 BASE DE SUPORTE

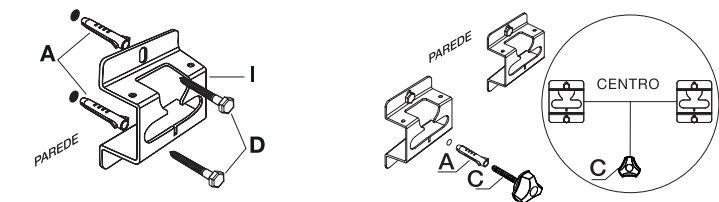
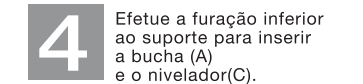
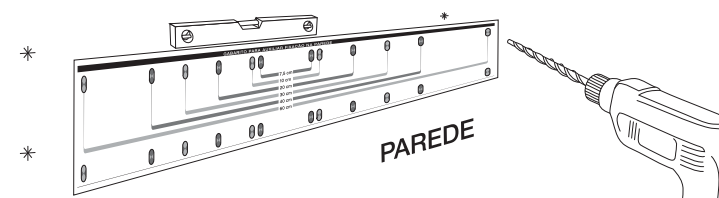
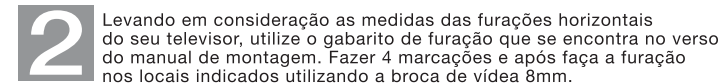
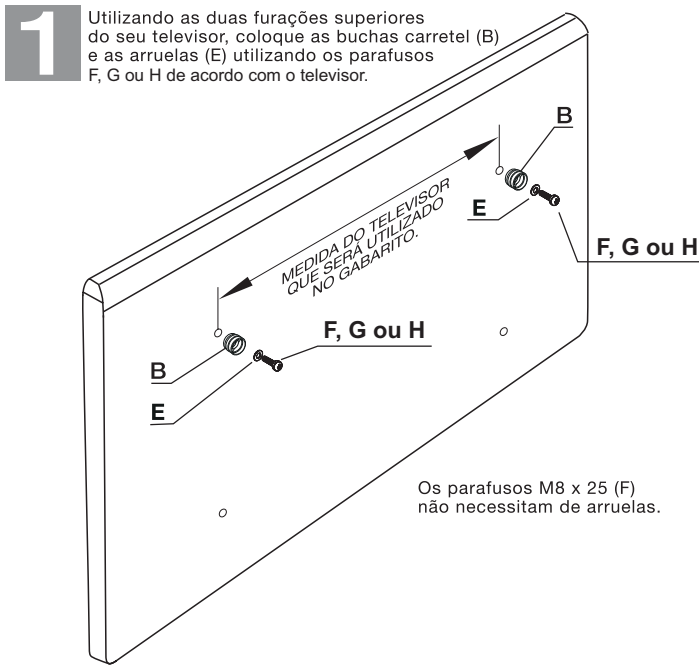

VISTA LATERAL

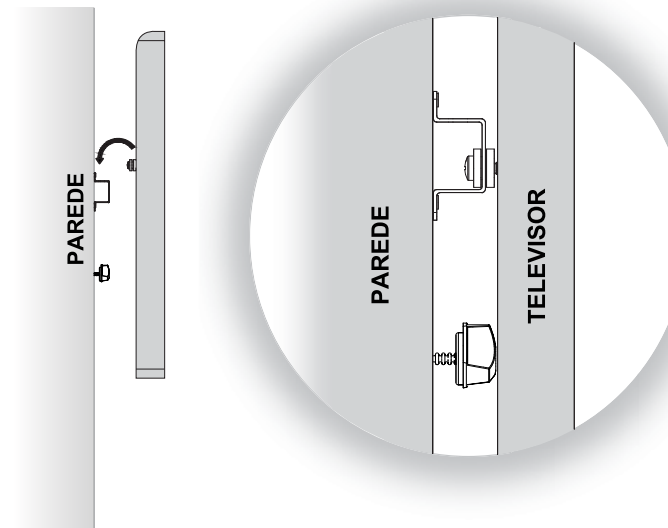

# GABARITO PARA AUXILIAR FIXAÇÃO NA PAREDE

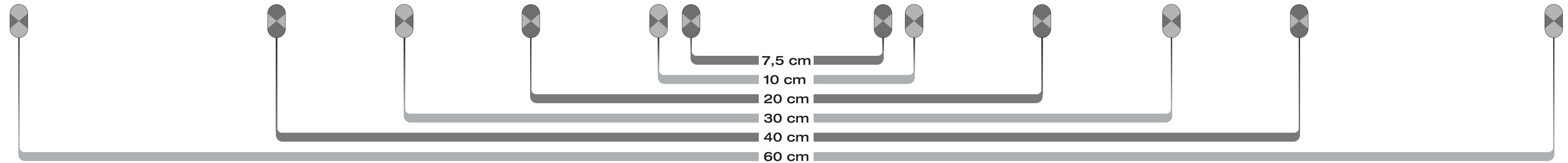

Após efetuada a furação e inserido o nivelador para o apoio da TV, certifique-se que o mesmo fique totalmente em apoio na parte inferior do televisor conforme ilustração.

